

SAVANT

POWER SYSTEM

Savant Power System Deployment Guide

RacePoint Blueprint™

Document Number:	009-2143-01
Document Date:	June 2022
Document Supports:	da Vinci 10.1 or higher

This document guides the installer through the process of deploying and configuring an Savant Power System and integrating it into a Savant Pro Smart Home System using RacePoint Blueprint, including:

- OPTIONAL: Use the Savant Power & Light to set up Savant Power Modules or Lighting Controllers
- Create a Blueprint Layout for the Savant Power System
- Configure the Panel Bridge Controller & Savant Power Modules in Blueprint
- Configure Power Sources (Generator or a Battery Storage System) in Blueprint
- Configure the Smart Energy Monitor in Blueprint
- Create Energy Scenes to control power usage off the Grid in Blueprint

Table of Contents

To access links to the topics within this document, click the corresponding entry in the table below.



Important Information.....	3	Appendix A: Savant Power Module PAIR Button Functions	26
1. Before You Begin	4	Appendix C: On-Device Setup.....	27
2. Third Party Documentation.....	4	Appendix D: Savant Power & Light App Setup.....	28
3. Deployment Steps	5	Appendix E: Device Discovery	30
4. OPTIONAL Savant Power & Light App Integration	5	Appendix F: Power & Light Dashboard.....	31
5. Layout Configuration.....	6	Appendix G: Get Config	32
5.1. Savant System.....	6	Appendix H: Test Circuits.....	33
5.2. Schneider	7	Appendix I: Add Breaker Panel.....	34
5.3. Sol-Ark.....	9	Appendix J: Pair Modules	35
5.3. Automatic Generator	10	Appendix K: Lighting.....	36
6. Add Panel Bridge Controller.....	11	Appendix L: Upload Config to Host.....	40
6.1. Configure Bridge Controller.....	12	Appendix M: System Information Checklist.....	41
7. OLA Configuration (Optional)	13		
7.1. OLA Universe Settings.....	13		
7.2. Pair Savant Power Modules.....	14		
8. Smart Groups	15		
8.1. Configure Smart Groups	16		
8.2. Sync.....	16		
8.3. Smart Group Settings.....	17		
9. MicroGrid Controller Settings	18		
10. Energy Monitoring Settings	19		
11. Whole Home Backup.....	20		
12. Off Grid Energy Scenes	21		
12.1. Global Settings.....	22		
12.2. Create Energy Scene	23		
13. Energy Loads.....	23		
13.1. Energy Load Settings.....	24		
14. Upload Configuration	25		

Important Safety Information - Read First



Before installing, configuring, or operating any equipment, Savant recommends that each dealer, integrator, installer, etc. access and read all relevant technical documentation. Savant Power technical documentation can be located by visiting Savantpower.com. Vendor documentation is supplied with the equipment.

Read and understand all safety instructions, cautions, and warnings in this document and the labels on the equipment.

Safety Classifications In this Document

NOTE:	Provides special information for installing, configuring, and operating the equipment.
 IMPORTANT!	Provides special information that is critical to installing, configuring, and operating the equipment.
 CAUTION!	Provides special information for avoiding situations that may cause damage to equipment.
 WARNING!	Provides special information for avoiding situations that may cause physical danger to the installer, end user, etc.

Electric Shock Prevention

 ELECTRIC SHOCK!	The source power poses an electric shock hazard that has the potential to cause serious injury to installers and end users.
 ELECTRICAL DISCONNECT:	The source power outlet and power supply input power sockets should be easily accessible to disconnect power in the event of an electrical hazard or malfunction.

Weight Injury Prevention

 WEIGHT INJURY!	Installing some of the Savant equipment requires two installers to ensure safe handling during installation. Failure to use two installers may result in injury.
---	--

Safety Statements

All safety instructions below must be read, understood, and carefully followed under all applicable circumstances when working with any Savant equipment.

1. **Follow all input power ratings marked on product near power input!**
2. If fuse replacement is required, replacement fuse should match fuse rating marked on the product.
3. Do not use equipment near water.
4. Clean only with dry cloth.
5. Do not block any ventilation openings or install near any heat sources such as heat registers, stoves, radiators, amplifiers, etc.
6. Refer all servicing to qualified service personnel. Servicing is required when any part of the apparatus has been damaged in any way, or fails to operate normally for any reason.
7. Use only attachments/accessories specified by the manufacturer, following all relevant safety precautions for any such attachments/accessories.
8. For applicable equipment, use the included power cord with the grounding prong intact to insure proper grounding of the device.
9. If the provided plug does not fit the desired outlet, contact a licensed electrician to replace the obsolete outlet.
10. Protect any power cord from being walked on, pinched, strained, or otherwise potentially damaged, especially at the outlet or device connections.
11. Disconnect any outlet powered apparatus from its power source during lightning storms or when unused for long periods of time.
12. To completely disconnect equipment from AC mains power, disconnect the power supply cord plug from the AC receptacle on the device.
13. For any hardwired or fixed in-wall apparatus, carefully follow all wiring diagrams and instructions. All electrical wiring and servicing should be performed by a properly licensed electrician.

1. Before You Begin

 **IMPORTANT!:** This document assumes the installer has read through and completed all applicable steps in the [Savant Power System Wiring Configuration and Installation Guide](#).

Read this document in its entirety before starting deployment of the product, and ensure that the following items are available:

1. Savant Development Environment.....
2. Pro Host or Super Pro Host (SVR-5100, SVR-7000S)
AND
3. Smart Controller (SSC-0012 or any controller with available GPIO and RS485 ports)
OR
4. Smart Host (SHR-2000).....
5. Panel Bridge Controller (PBC-1000)
6. Smart Energy Monitor (SEM-2015).....

2. Third Party Documentation

 **IMPORTANT!:** This document assumes the installer has read all relevant 3rd party documentation. Read all manufacturer documentation for all 3rd party products in use; which may include, but are not limited to:

Schneider Fortress

- [eFlex Installation Manual](#)
- [Schneider Electric XW Pro inverter](#)
- [Generac Automatic Transfer Switch Manual](#)

Sol-Ark

- [Sol-Ark 12k Manual](#)
- [Sol-Ark 15k Manual](#)

NOTES: For Savant Power Systems with Generator integration, locate the specific **Installation & Operations** manual for the generator in use and complete the generator installation process.

3. Deployment Steps

To successfully deploy a Savant Savant Power System, follow the steps listed below. This page can be used as a checklist to track progress as items are completed.

 **IMPORTANT NOTE!** The steps listed in this document can be completed with or in conjunction with the **Savant Power & Light** app. For more information, see the [Appendix C: Savant Power & Light App Setup](#).

1. Complete On-Device Setup
See [On-Device Setup](#)
2. Add Devices to RacePoint Blueprint.....
See [Layout Configuration](#)
3. Discover Panel Bridge Controller and Pair Modules.....
See [Panel Bridge Controller](#) and [OLA Configuration](#)
4. Organize Loads into Smart Groups
See [Smart Groups](#)
5. Configure MicroGrid Settings.....
See [MicroGrid Settings](#) and [Power Source](#)
6. Deploy Energy Monitoring.....
See [Energy Monitoring](#)
7. Add Off Grid Energy Scene
See [Off Grid Energy Scenes and Energy Loads](#)
8. Upload Configuration to the Savant Host.....
See [Upload Configuration](#)

4. OPTIONAL Savant Power & Light App Integration

The Savant Power & Light App can be used to deploy and configure all devices listed within this document interchangeably.

Energy Savant Power System

- [Appendix C: Savant Power & Light App Setup](#) and all subsequent appendices before [Appendix J: Lighting](#) describe configuration of all device-specific settings.
- All changes within the Savant Power & Light App will not take effect until the configuration is uploaded to the Savant Host.

Lighting Savant Power System

-  **IMPORTANT!** [Appendix J: Lighting](#) describes deploying Panelized Lighting, DMX and 0-10V Lighting. Once all steps within this appendix have been completed, begin at [Section 5](#).

5. Layout Configuration

Complete only the steps within this section that apply to the equipment being installed. This section assumes there is not an existing Savant Power system. Only complete the sub sections within this section that apply to the equipment installed.

5.1. Savant

Each device within the Savant Power system is represented in Racepoint Blueprint as a **profile**. Within the open Blueprint configuration, the following:

1. Click **Show Library**.
2. Search for the type of Host and drag and drop it into the **Layout** Pane.
3. Search for a **Generic NetworkSwitch** and place it in the Layout Pane.
4. (**Pro Host Only**) Search for the model of Savant Smart Controller. Place it in the Layout Pane.

⚠ IMPORTANT!: For systems containing a Sol-Ark energy solution, the Smart Controller must support **RS485** connections.

5. Inspect the Savant Host (**CMD + I**)
6. In the UID Field, enter its UID.
7. (**Pro Host Only**) Repeat steps 6 and 7 for the Savant Controller.

To the right is an example configuration before any optional energy monitoring, generator, or battery storage equipment is installed.

(OPTIONAL) Add Energy Monitor

1. Search for “Savant Energy Monitor”. Drag and drop the **SEM-2015** into the Layout Pane.
2. Make an ethernet connection between the SEM-2015 and the Network
3. Inspect the Profile (**CMD + I**).
4. Enter its Savant **Unique Identifier Number** (UID).

⚠ IMPORTANT NOTE!: For sites using an SEM-2015, follow the steps before continuing Savant Power System deployment:

- Wire the SEM-2015 per the wiring diagrams listed in the [Savant Power System Wiring Configuration and Installation Guide](#), based on the system type being deployed.
- Confirm that VT and CT wiring placements match the diagram.
- See the [Standalone Energy Monitoring Deployment Guide](#) and confirm all steps for deployment have been completed.

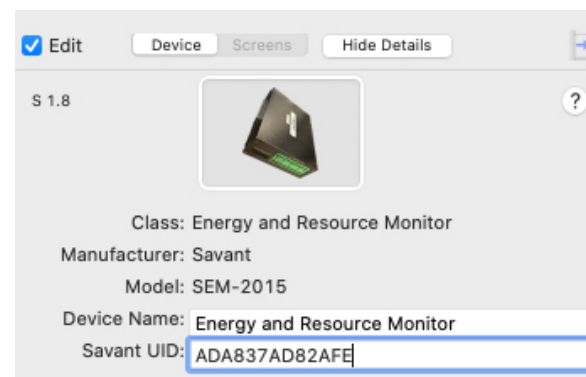
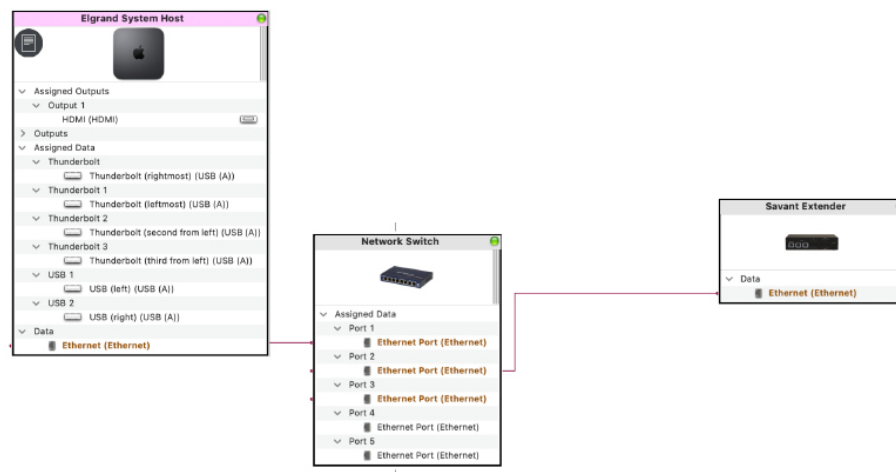

5.2. Schneider

A Savant System integrating a Schneider battery Energy Storage System requires a Conext Gateway and ATS Sensor to be added to the Blueprint configuration.

Conext Gateway

1. Within the profile library, search for “Schneider”.
2. Drag and drop the **Schneider Electric Context Gateway** into the Layout Pane.
3. Name the Gateway as it will appear in the Savant Pro App.
4. Right-click the ethernet port of the Gateway profile.
5. Select a port on the Network switch from [section 5.1 step 3](#).



ATS Sensor

1. Search for “Generic _GPIO Sense” profile. This profile represents the **ATS Sensor**.
2. Drag and drop the **Generic _GPIO Sense** into the Layout Pane.
1.  **IMPORTANT:** Name the component “**ATS Sensor**”.
2. Inspect the Generic _GPIO Sense profile.
3. Connect the GPIO port to the matching port on the Savant Controller added in [section 5.1 step 4](#).

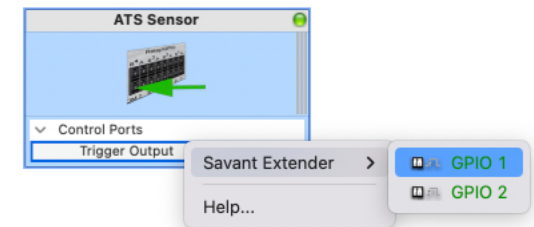
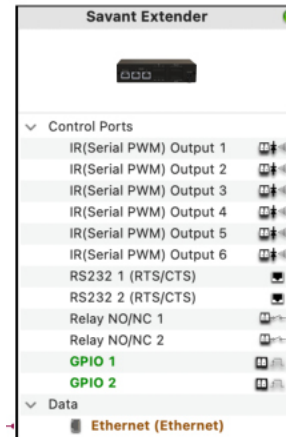

Example Schneider Configurations

Smart Host and Schneider ESS

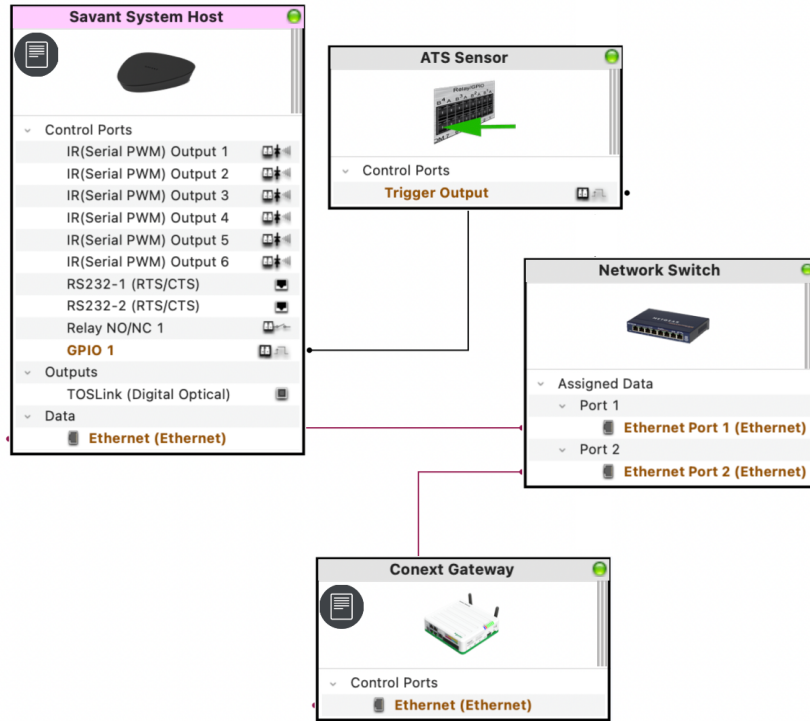

Pro Host and Schneider ESS

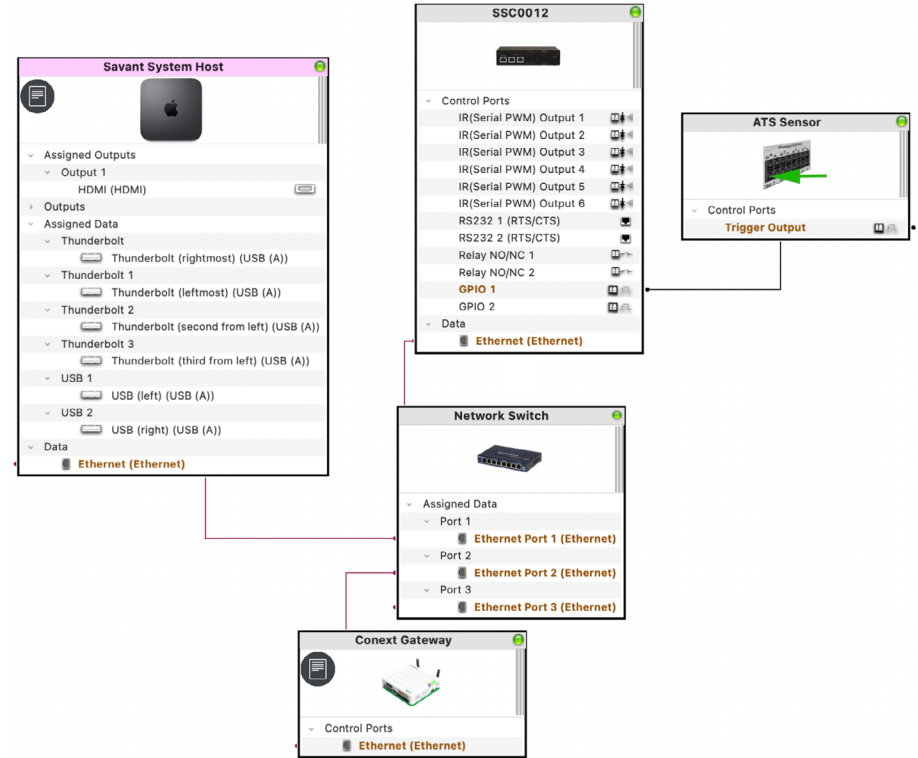

5.3. Sol-Ark

Sol-Ark inverter configuration with Blueprint varies depending on the model and quantity of inverters. Follow the steps below:

1. Click **Show Library**.
2. Search for “Sol-Ark”.
3. Savant supports Sol-Ark 12k inverters. Drag and drop the matching **Sol-Ark 12k (Microgrid)** profile into the Layout Pane.
4. For sites with multiple Sol-Ark inverters, Savant will communicate with one parent Sol-Ark. Drag and drop one **Sol-Ark sub** profile per additional inverter into the Layout Pane.
5. Right-click the RS485 port on the Sol-Ark 12k profile and select the matching RS485 port on the Savant Smart Controller.
6. Right-click the ethernet port of the Sol-Ark 12k profile and select a port on the network switch selected in [section 5.1 step 3](#).

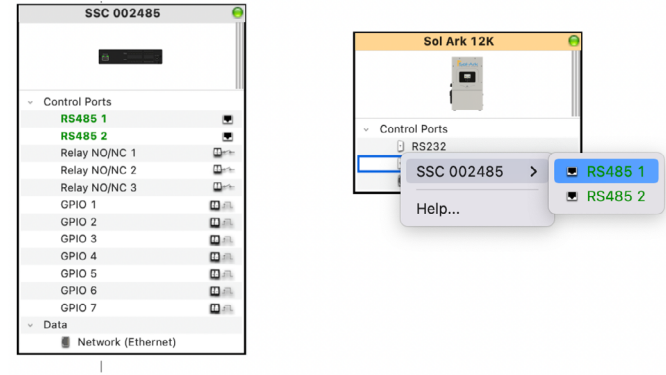

Below are examples of both Smart Host and Pro Host configurations with one or more Sol-Ark inverters.

Smart Host and Single Sol-Ark

Pro Host and Dual Sol-Ark

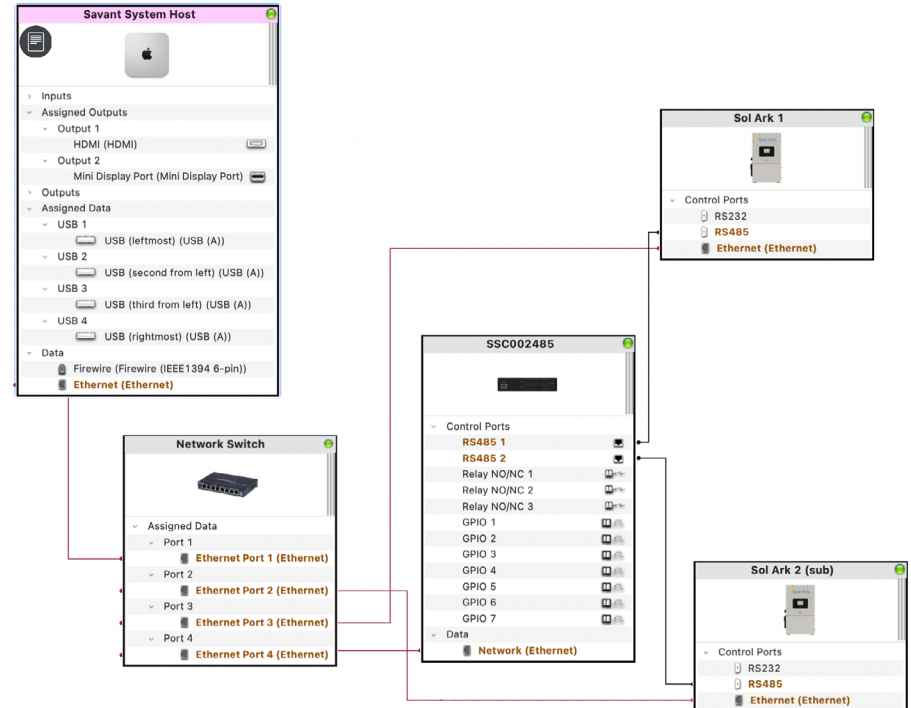
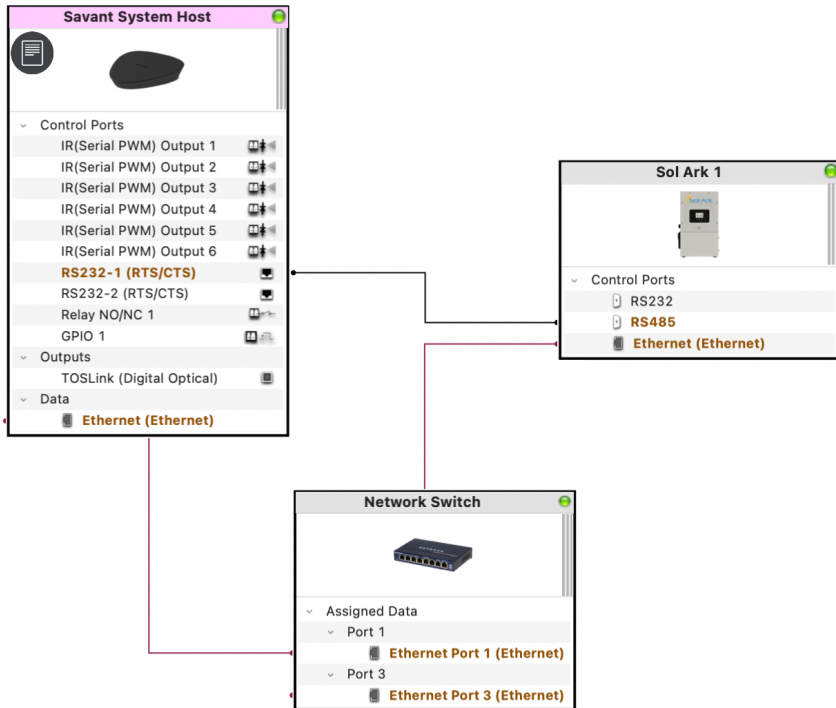

5.4. Automatic Generator

All automatic generators with a GPIO control port can be integrated into a Savant Power System, however they cannot be represented

1. Within the profile library, search for Generator.
2. Drag and drop the **Generator (Automatic)** profile into the Layout pane.
3. Connect the GPIO control port of the Generator (Automatic) to a GPIO control port on a Savant controller or Host, matching the physical installation.

Example Configuration

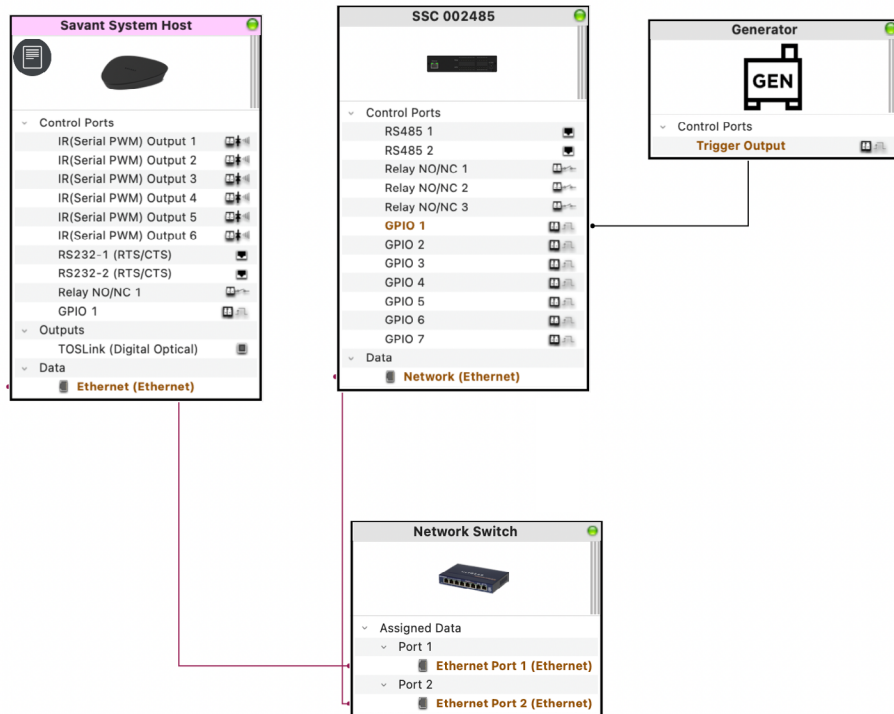

6. Add Panel Bridge Controller

Panelized Lighting controllers that use OLA or DMX servers can be discovered using the Panel Bridge Controller and their loads automatically discovered. This section is the Blueprint equivalent of the Savant Power & Light app [Appendix I: Device Discovery](#) and should be skipped if that has been completed. To scan the network for a controller, do the following:

Discover Panel Bridge Controller

1. Navigate to **Tools > Savant Lighting and Keypads** from the Blueprint menu bar or click **Manage Lighting & Shades**.
2. Within the **Keypads and Controllers** tab, Select the expand frame icon to open the **Discovered** frame.
3. Select the Discover button to scan for and discover all the lighting devices on the network.
4. Click **Stop Discover** when PBC Controllers communicating on the network are located.

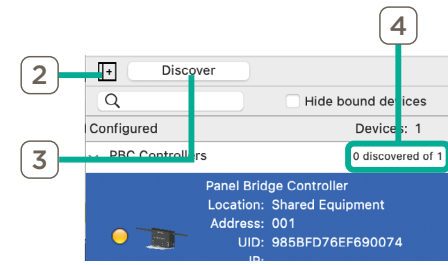

Add to Configuration

Once the Panel Bridge Controller has been discovered, all Savant Power Modules must be paired to it.

IMPORTANT NOTE! Only add PBC components through the Keypad Manager.

1. Expand the **PBC Controllers** list.
2. Highlight the controller.
3. Click **Add to configuration**. The controller will show a gear icon and appear in the Configured frame and bound to the configuration (with UID added), along with the Savant Power Modules in Pairing Mode.
4. Drag the PBC from the Component Palette in the main blueprint view into the configuration and connect the ethernet port.

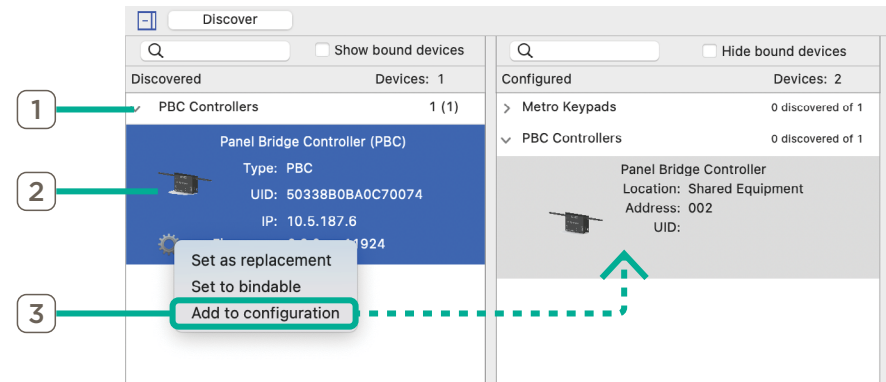

6.1. Configure Bridge Controller

1. Highlight the Panel Bridge Controller.
2. In the **Overview** frame that opens, enter a name for the Panel Bridge Controller.
3. Select the location of the loads that the PBC will be controlling.

NOTES:

- A warning message will appear directing user to generate services. This is required whenever the **Location** field is modified.
- Confirm the controller has been successfully discovered and bound by ensuring the LED icon state is green. All possible states are listed below.

Green LED	Device was discovered and is bound to the configuration loaded in Blueprint.
Yellow LED	The device was not discovered but is bound to the configuration loaded in Blueprint.
Red LED	The device was not discovered and is not bound.

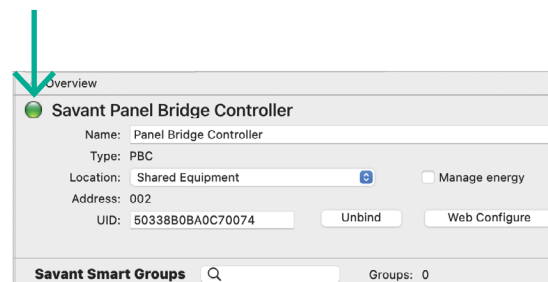
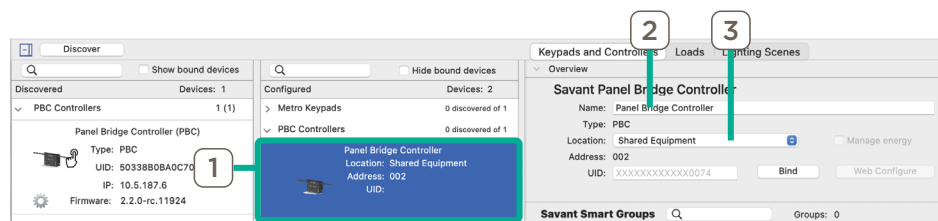

7. OLA Configuration

The **Web Configure** button within Manage Lighting and Shades seen in [Section 6.1](#) opens a connection to the OLA server. The **Universe Settings** within the OLA server must be configured before pairing any Savant Power Modules to a Panel Bridge Controller. Required settings within the Panel Bridge Controller's embedded OLA server Web UI are described below:

⚠ IMPORTANT!: When using the Savant Power & Light App, if [Appendix I: Pair Modules](#) has been completed, skip this section.

7.1. Universe Settings

The **Savant Lighting Universe** supports all Savant lighting and energy controllers.

1. Expand the **Universes** field (Select the + icon)
2. Select the Universe labeled **Savant Lighting**.
3. Select the **Settings** tab.
4. **OPTIONAL:** If desired, the Universe Name field can be changed to a job/site specific name. To modify, double click this field and rename.

In this example, the name was changed to **PBC Master Bdrm** as shown in image.

5. Verify that the **Art-Net** network is checked.
6. Select **Save** when complete.

For more information on OLA Servers, see the [Savant Panelized Lighting Guide, Appendix A: OLA Server Information](#).

The top screenshot shows the OLA web interface. On the left sidebar, 'Universes' is expanded (1) and 'Savant Lighting' is selected (2). The main content area shows a table of 'Active Universes' with one entry: Universe # 1, Universe Name Savant Lighting, Input Ports 0, Output Ports 1, and RDM Devices 3. Below the table is an 'Add Universe' button. The 'Server Info' section displays: Hostname DMXController, Primary IP 10.10.0.155, Primary Broadcast Address 10.10.0.193, Primary MAC Address 98:84:c6:88:51:0d, Instance Name OLA Server, Version 0.10.7, and Started Mon Mar 25 17:55:30 2019. 'Reload Plugins' and 'Stop OLA' buttons are at the bottom.

The bottom screenshot shows the 'Settings' tab (3) for the 'Savant Lighting' universe. The 'Universe Settings' section has 'Universe Id' 1 and 'Universe Name' 'PBC Master Bdrm' (4). 'Merge Mode' is set to 'LTP'. The 'Input Ports' section has a table with one entry: Device ArtNet [127.0.0.1] (5), Description ArtNet Universe 1:0:1, and Priority Not Supported. The 'Output Ports' section is empty. An 'Add Additional Ports' button is at the bottom. A 'Save' button (6) is at the bottom right.

7.2. Pair Savant Power Modules

Savant Power Modules communicate to the PBC using the OLA server. To establish this communication, Savant Power Modules must be paired to the PBC.

NOTE: The pairing process can be completed within the Savant Power & Light App. For more information on this, see [Appendix I: Pair Modules](#).

1. Apply power to the Power Modules by first powering the breaker panel containing the Savant Power Modules and then toggling the breaker connected to the Savant Power Modules to the **ON** position.
2. Verify all connections are correct by toggling the **Circuit Power** switches to the **ON** position. The loads properly connected to the Power Modules will turn on.

! IMPORTANT!: Return the Circuit Power switches to the **AUTO** position when satisfied wiring is correct.

3. Press and hold the **PAIR** button on the Savant Power Module until the gear icon appears; then release.
4. On the OLA Server, select **RDM** tab if it is not already open.
5. Select the **Discover** icon .
6. The two outputs to the Savant Power Module will appear in the OLA Server Web UI.
7. After 10 seconds, the module will automatically connect to the Panel Bridge Controller. Verify the Bluetooth icon has replaced the gear icon on the module LED screen.
8. Repeat steps 3 through 7 to pair any remaining modules with the PBC Controller.

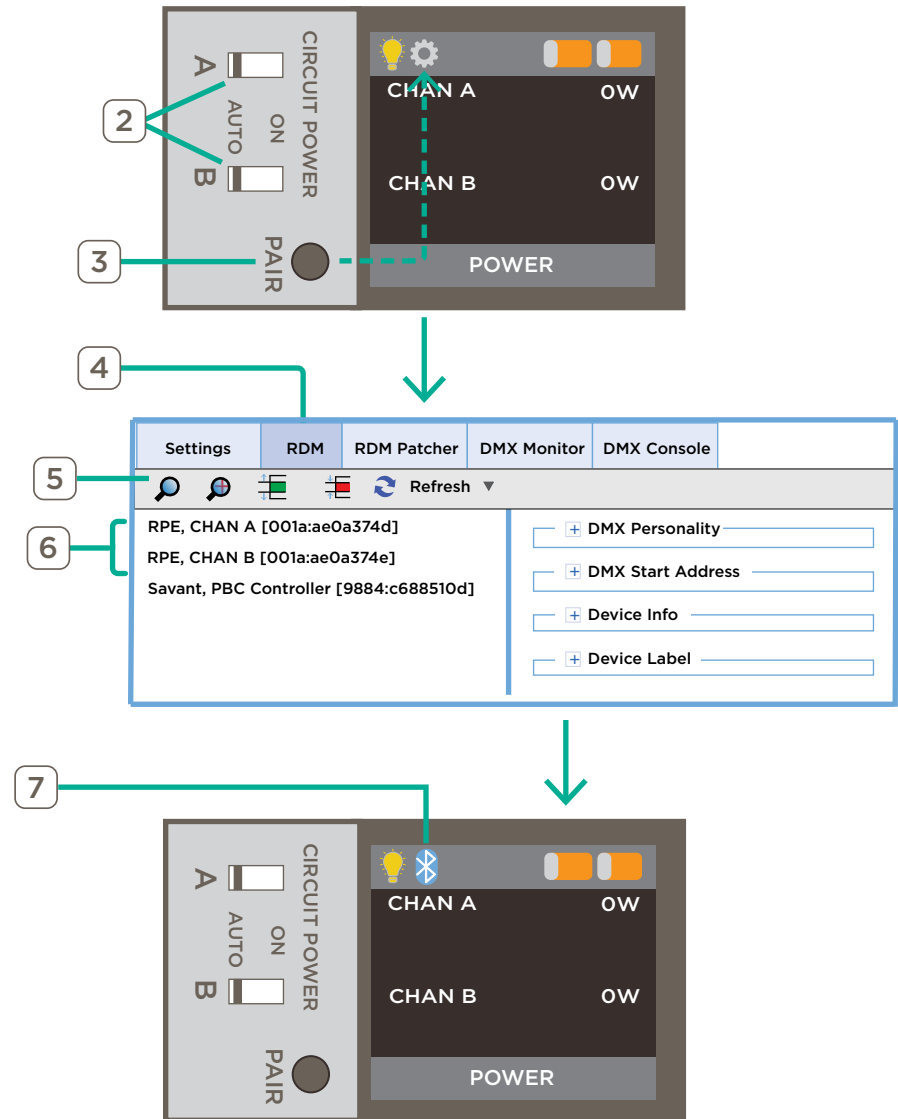

8. Smart Groups

Once all Power Modules have been paired, this information must be imported into Blueprint. This process is completed within the Savant Energy Manager screen.

Scan for Savant Power Modules

1. Highlight the Panel Bridge Controller.
2. Click the **Connect** button to connect the PBC to the lighting/keypad manager. **Connected** will appear beside the PBC when connected.
3. Select the **Start Scan** button to begin querying/scanning the previously configured OLA information about the Savant Power Module loads.
4. Once all Savant Power Modules appear, click **Stop Scan**.

NOTES:

- This process may take a few moments.
- Each load will populate in the **Savant Smart Groups** frame as a separate Smart Group.
- Select the disclosure arrow to expand each Smart Group.

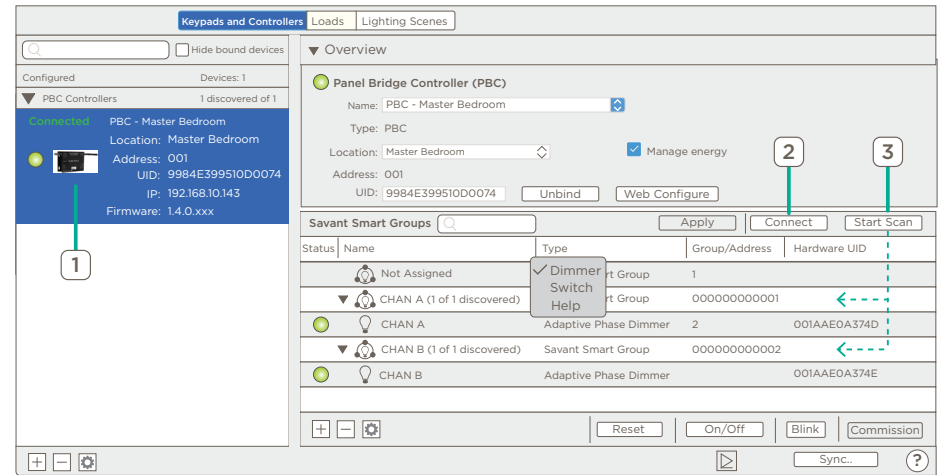

Test Circuit

While connected to the Panel Bridge Controller, individual loads can be toggled on and off. Use this functionality to verify the loads are labeled correctly and installed in the correct location.

1. Click the disclosure arrow to display all loads within a Smart Group.
2. Highlight one of the loads.
3. Select the **On/Off** button and verify that the loads toggle power On and Off.

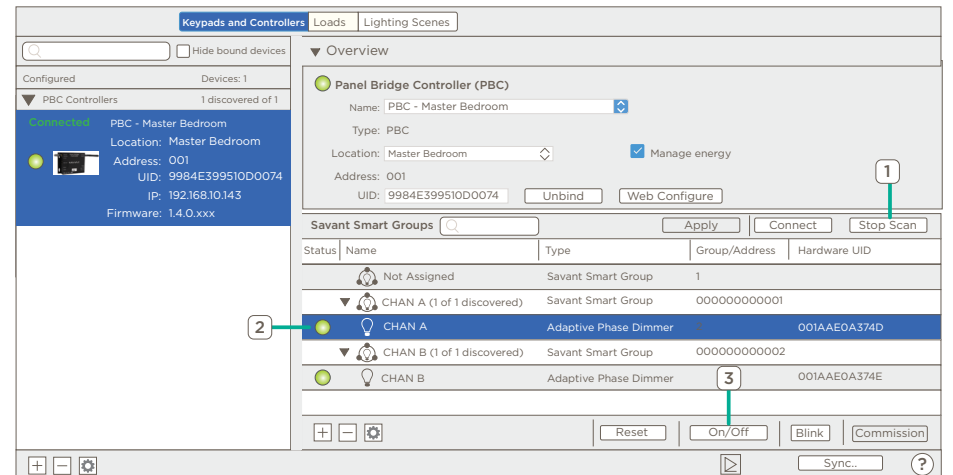

8.1. Configure Smart Groups

A Smart Group is a group that contains one or more Savant Power Module loads. Savant Lighting scenes contain both base loads and smart groups. During the scanning process, each Savant Power Module lighting load is automatically added to a smart group. Each smart group created will generate an entity such as a slider or button in the Pro App. The sections below describes how to create smart groups and move loads between them.

⚠ IMPORTANT NOTE: SKIP THIS SECTION if a single slider or button for will be used for control of lighting loads within the Savant Pro App.

Adding and Removing Smart Groups

1. Select the **Add** icon  to create and add a new smart group to the lighting/keypad manager.
2. Double-click the smart group and rename to a label that identifies the group. The name entered is what is populated in the Savant UI.
3. Drag and drop loads to assign them to the new group.

NOTES:

- For information on all Savant Smart Group Fields, see [Smart Group Settings](#).
- To remove a smart group, move any loads assigned to this group to other smart groups. Select the smart group to be removed then select the **delete** icon .

Move Loads between Smart Groups

- To move a load between smart groups, drag and drop the load into the desired group. In diagram to the right, a lighting load is dragged from the CHAN B smart group to the CHAN A smart group.
- Once moved, all loads in the group will be controlled by the same button or slider entity that gets added to the Savant UI.

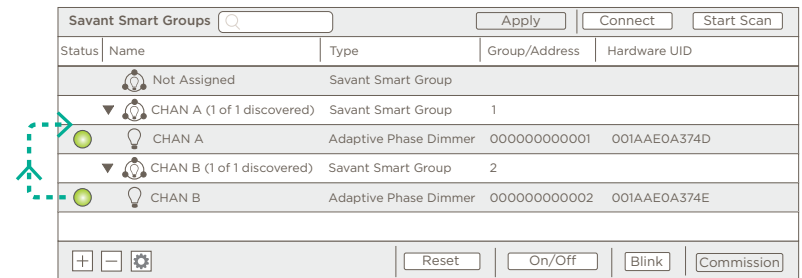
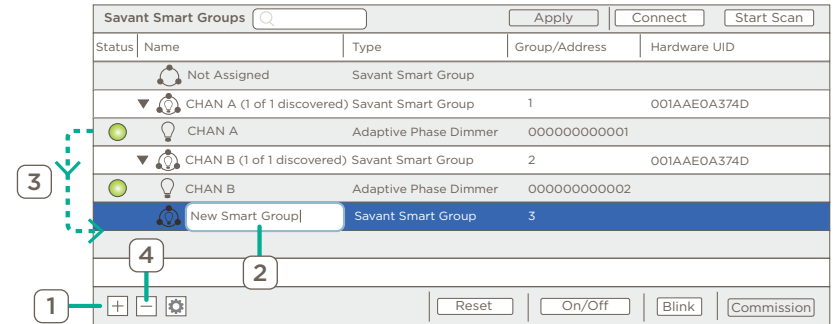

Sync Data Table for Controller: Savant System Host

When the box is selected it will add/rename/delete entries in the lighting data table to match the current wireless lighting configuration. When de-selected it will delete any entries in the lighting data table that were created as a result of the wireless lighting configuration.

Loads

Scenes

Load Scenes

Buttons

Reset any user modifications
If selected the entire row for each entry will be replaced so any modifications will be reset to default.

8.2. Sync

1. Click **Sync**.
2. Select **Loads** and **Scenes** and click **Ok**.

⚠ IMPORTANT NOTE: After the Manage Lighting & Shade window closes, drag the Panel Bridge Controller from the Devices pane to the **Layout** pane.

8.3. Smart Group Settings

NOTE: If [On-Device Setup](#) has been completed, this table will be pre-configured.

Savant Smart Groups <input type="text" value=""/>						
Groups: 8						
Status	Name	Type	Group/Address	Hardware UID	Location	Energy only
	Not Assigned	Savant Smart Group				
>	Car Charger (0 of 1 discovered)	Savant Smart Group	1		Room 1	<input checked="" type="checkbox"/>
>	Bedroom Lights (0 of 1 discovered)	Savant Smart Group	2		Room 1	<input type="checkbox"/>
>	Oven (0 of 1 discovered)	Savant Smart Group	3		Room 1	<input checked="" type="checkbox"/>
>	Bath Lights (0 of 1 discovered)	Savant Smart Group	4		Room 1	<input checked="" type="checkbox"/>
>	PowerLink (0 of 1 discovered)	Savant Smart Group	5		Room 1	<input checked="" type="checkbox"/>
>	Hall Lights (0 of 1 discovered)	Savant Smart Group	6		Room 1	<input checked="" type="checkbox"/>
>	LR Lights (0 of 1 discovered)	Savant Smart Group	7		Room 1	<input type="checkbox"/>
>	Dishwasher (0 of 1 discovered)	Savant Smart Group	8		Room 1	<input checked="" type="checkbox"/>

+ - ⚙️
Reset On/Off Blink Commission

Search Bar	Type the Savant Power Module Name into the search bar to display all Savant Power Modules with the text in their name.
Status	Status of the Savant Power Module. Green: Connected Yellow: Discovered but not configured. Red: Created but not discovered.
Name	Name of the Savant Power Module.
Type	Type of Savant Power Module or Group.
Group/Address	Which group the Savant Power Module is in or its individual address.
Hardware UID	Unique Identifying Number (UID) of the Savant Power Module.
Location	Location of the Savant Power Module as represented within the Savant Pro App
Energy Only	Checked: Savant Power Module controls energy loads. Unchecked: Savant Power Module controls lighting loads.
(+/-) Add or Remove Group	Create or remove a Smart Group.
Expand or Collapse All	Expand all entries or collapse them.
Reset	Reset any binding between the Power Module and Host.
On/Off	Toggle all devices connected to the Savant Power Module On and Off.
Blink	Toggles all loads connected to the selected Savant Power Module On and Off to assist in identification.

9. MicroGrid Controller Settings

The settings for all Power Sources must be entered into Blueprint correctly to ensure proper functionality. Navigate to **Tools > Settings > Microgrid Controller** and configure the settings below.

The screenshot shows the 'MicroGrid Controller Settings' window. It includes the following fields:

- Generator Capacity:** A text input field with 'kW' as a unit.
- Controller Address:** A sub-section containing:
 - Host Name / IP:** A text input field with '10.18.215.17'.
 - Port:** A text input field with '503'.
- Battery Capacity:** A text input field with '18.5 kWh'.
- Storage Inverter Capacity:** A text input field with '6.8 kW'.

Numbered callouts (2, 3, 4) point to the Controller Address, Battery Capacity, and Storage Inverter Capacity fields respectively.

The screenshot shows the 'Sol-Ark Settings' window with the following settings:

- Island Mode Exit SOC:** 50 % SOC
- Battery Capacity:** 18.5 kWh
- Storm Mode Charge Battery SOC:** 90 % SOC
- Generator Charges Battery Threshold:** 20 % SOC
- Eco Mode Charge Battery SOC:** 20 % SOC
- Storage Inverter:** 12 kW
- Solar Inverter:** 12 kW
- Generator Capacity:** 0 kW
- Generator Charges Battery**
- Use External Utility CT**

Buttons for 'Cancel' and 'OK' are at the bottom.

IMPORTANT NOTES:

- These settings must be configured before Energy Scenes are created.
- Scene Budget in the Energy Scene Manager is 90% of the capacity of the generator or battery capacity in this window.

Generator Settings

Generator Capacity	Total capacity of the generator in kWh
--------------------	--

Battery Settings

Host Name / IP	IP address of the inverter.
Port	Port of the inverter.
Battery Capacity	Total capacity of the battery in kWh.
Storage Inverter Capacity	Total capacity of the inverter in kW.

Sol-Ark Settings

Island Mode Exit SOC	Percentage in which the system will automatically exit Island mode and connect to the grid.
Battery Capacity	Total battery capacity in kWh.
Storm Mode Charge Battery SOC	Percentage in which the system will maintain the battery charge at when in Storm Mode.
Generator Charges Battery Threshold	Percentage at which the generator will activate to charge the battery if no other source is available.
Eco Mode Charge Battery SOC	Percentage in which the system will automatically enter Eco Mode.
Storage Inverter	Total capacity of the storage inverter in kW
Generator Capacity	Total capacity of the generator in kWh
Generator Charges Battery	When checked, the generator charges the battery when threshold is reached.
Solar Inverter	When enabled, maximum kW the Solar inverter can input into the system.
Use External Utility CT	When enabled, use external current transformer. When disabled, use the internal Sol-Ark Current Transformer.

10. Energy Monitor Settings

The settings within **Tools > Energy Monitoring Settings** must represent all circuits monitored by a Savant Energy Monitor for the circuits to be visible within the Savant Pro App. If [Appendix C: On-Device Setup](#) has been completed and the Panel Bridge Controller and has been bound, the Energy Monitoring table will have all entries pre-configured. To add an entry, click the plus sign in the bottom left corner and then fill out the following fields:

Energy Consumption: 100 kW

Enabled	Circuit Description	Classification	Image	Group Image	Group	Monitoring Device	Channel	Size	Voltage Source	Link	Parent Circuit	Control	Savant Zone	Production Type
<input checked="" type="checkbox"/>	> Car Charger	Consumption			Garage	Panel Bridge Controller			None		None	Choose...	Room 1	
<input checked="" type="checkbox"/>	> Bedroom Lights	Consumption			Lighting	Panel Bridge Controller			None		None	Choose...	Room 1	
<input checked="" type="checkbox"/>	> Oven	Consumption			Stove	Panel Bridge Controller			None		None	Choose...	Room 1	
<input checked="" type="checkbox"/>	> Bath Lights	Consumption			Lighting	Panel Bridge Controller			None		None	Choose...	Room 1	
<input checked="" type="checkbox"/>	> PowerLink	Consumption			Outlet	Panel Bridge Controller			None		None	Choose...	Room 1	
<input checked="" type="checkbox"/>	> Hall Lights	Consumption			Lighting	Panel Bridge Controller			None		None	Choose...	Room 1	
<input checked="" type="checkbox"/>	> LR Lights	Consumption			Lighting	Panel Bridge Controller			None		None	Choose...	Room 1	
<input checked="" type="checkbox"/>	> Dishwasher	Consumption			Dish Washer	Panel Bridge Controller			None		None	Choose...	Room 1	

- (A) Energy Consumption** Total amount of energy that can be consumed by all Circuits.

- (B) Enabled** Whether the circuit is enabled or not.

- (C) Circuit Description** Name of the Circuit as it will appear in the Savant Pro App.

- (D) Classification** Whether the load is Feed, Consumption, or Production.

- (E) Image** The image associated with the load in the Savant Pro App.

- (F) Group Image** The image associated with the group the load is in.

- (G) Group** Name of the group the circuit is in.

- (H) Monitoring Device** Which Panel Bridge Controller is used to monitor the specific circuit.

- (I) Channel** Click the arrow dropdown next to the Circuit description to change the Phase channel number.

- (J) Size** Size of the circuit in Amps.

- (K) Voltage Source** The Voltage Transformer used to monitor the device.

- (L) Link** Powerlink or contactor used to control the load if above 60A.

- (M) Parent Circuit** Select the Parent Circuit here.

- (N) Control** Which service the Savant Power Module will appear under within the Savant Pro App.

- (O) Savant Zone** Zone in the Savant Pro App the circuit will appear in.

- (P) Production Type** **(Production Classification)** Type of production.

11. Whole Home Backup

A Savant Power System with **Whole Home Backup** has enough energy in reserve that the Power Source Backup (Battery or Generator) can provide power for the maximum total load of the home for an extended period of time. As such, Whole Home Backup systems **do not require an Energy Budget for Off Grid Scenes** and additional areas of functionality become available.

IMPORTANT NOTES!:

- **SKIP THIS SECTION** if the Savant Power System does not support Whole Home Backup.
- If the system does not support Whole Home Backup, the Whole Home Backup checkbox **must be unchecked**. See [Global Settings](#).

Service Power Source

The Power Sources screen can be used to associate Savant Power Module channels with components in the Blueprint Configuration if Whole Home Backup is enabled. When associated, Savant Power Modules will automatically power on these channels when a service request is made to this device.

To associate power sources with Savant Power Modules, navigate to **Tools > Energy Power Sources** and do the following:

Associate Components

1. Select the Savant Power Module channel controlling the component.
2. Select the component.
3. Click the checkbox next to the outlet.

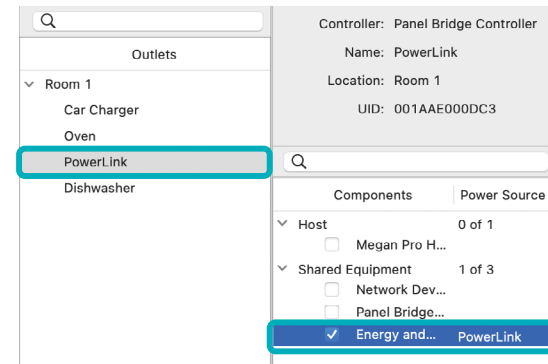

Add Custom Service Requests

For Savant Systems with custom triggers, it may be important to manually power on Savant Power Modules or execute custom service requests when the associated devices are powered on.

1. Click the **Plus (+)** sign to add any service requests to occur when the Savant Power Module channel is powered on.
2. Select the room for the Service Request to occur in.
3. Select the profile that will be executing the Service Request.
4. Select the Service Request.
5. Click **Add**.

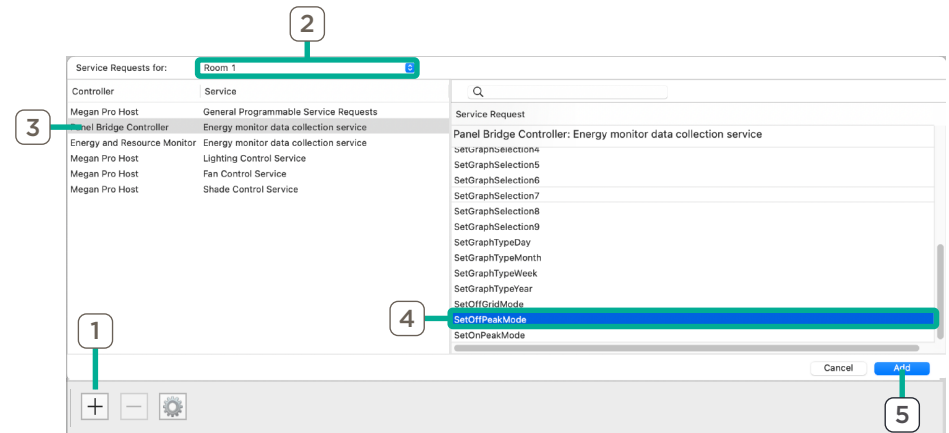

12. Off Grid Energy Scenes

Off Grid Energy Scenes control which circuits are enabled when the Grid is unavailable and the system is running on the Backup Power Source. For Savant Power Systems with a battery integrated, Off Grid Scenes can be created to activate based on the **Battery State-of-Charge (SoC)**.

To configure Energy Scenes, navigate to **Tools > Energy Manager** and configure the following:

12.1. Global Settings

Global settings effect all scenes as they represent settings dependent on the microgrid installed. Review the tables below for the available settings and their definitions.

Generator Global Settings

Generator Start Timeout	Amount of time before the generator is considered to have failed starting.
--------------------------------	--

Battery Storage Global Settings

Whole Home Backup	See Whole Home Backup .
Restore when on Grid	Enable to deactivate all scenes when the Savant System gains access to the Grid.
Grid available when ATS GPIO Low	Unchecked: If the Grid is available, the Savant Power System will behave as if the Grid is available when ATS GPIO is high . Checked: If the Grid is available, the Savant Power System will behave as if the Grid is available when ATS GPIO is low .

Energy System: **Generic Generator (Automatic)** Ver.: 1.5
Name: Energy and Resource Monitor Generator Start Timeout: seconds

Energy System: **Schneider Electric Context Gateway** Ver.: 1.10
Name: Energy and Resource Monitor
 Whole Home Backup Restore when on grid Grid available when ATS GPIO Low

12.2. Create Energy Scene

By default, the Essentials Off Grid Scene that activate automatically when there is a power outage. Additional Off Grid Scenes can be created for different scenarios, and can be activated by the user in the Savant Pro App. Furthermore, Off Grid Scenes can be created based on a schedule.

Add Scene

1. In the bottom left-hand corner of the Energy Manager screen, click the **Plus** sign to create a new **Energy Scene**.
2. Name the Energy Scene as desired.
3. Configure the conditions that must be present for the Energy Scene to occur:

Scene Conditions

Name	Name of the Scene as it will appear in the Savant Pro App.
Execute when Grid goes down.	When checked, this scene will occur automatically when the Grid goes down.
Execute when battery depletes to X%	Whether the scene will execute when the battery level depletes to the entered percent or not.
Type	Season, months, or days of the week the scene will automatically occur.

Add Energy Scene Service Request

Adding an Energy Service Request to an Energy Scene activates the selected service request whenever the scene is active.

Example: A service request can turn off a pool pump via a pool controller when an Energy Scene activates.

1. Click the **Plus (+)** Sign beneath Service Requests to create a new Service Request that will occur when the Energy Scene is activated.
2. Select the **Room** that the Service Request will occur in.
3. Select the device for the Service Request.
4. Choose the Service Request.
5. Click **Add**.

NOTE: Enter part of the name of the Service Request into the Search bar above Service Requests to search for specific services.

13. Energy Loads

Before configuring Energy Loads, its important to understand the Energy Budget and types of loads as they are handled within Blueprint.

Understanding the Energy Budget

The **Energy Budget** is a percentage of the maximum kW the power source can provide. This is handled automatically by Blueprint when the energy budget is configured for an Off Grid Scene.

- 10% of the inverter or generator size is held as **System Reserve**.
- The **System Reserve** is made available for all lighting and outlets to remain available in the event of a power outage. The remaining Energy Budget can be used for selected Critical Loads.

Scene Energy Budget

Energy Budget Total:	6,120 Watts
Energy Budget Used:	2,000 Watts
Energy Budget Remaining:	4,120 Watts

Dedicated Circuits

For proper Energy Scene functionality, dedicated loads and their max wattage must be defined. A **dedicated circuit** is a circuit that serves a single appliance or electrical fixture. No other loads are allowed to draw energy from a dedicated circuit. See the following table for examples of circuit classification for a 200 Amp service size home as a guide.

Examples of Circuit Classification for a 200A Service Size Home

Dedicated Circuits

- | | | |
|-----------------------------------|--------------------------|-----------------------------|
| - Kitchen Small appliance Circuit | - Basement Sump Pump | - Garage Door Opener(s) |
| - Sewer Ejection Pump Outlet | - Well Pump | - Bathroom GFCI Outlet(s) |
| - Microwave | - Furnace Air Handler | - Smoke Detectors (Bedroom) |
| - Electric Cooktop | - AC Condenser | - Basement Freezer |
| - Electric Range | - Washing Machine Outlet | - Garage Outlet(s) |
| - Fridge | - Electric Water Heater | - Car Charger |
| - Electric Dryer | - Dishwasher | |
| - Dining Room Outlets | | |

Non-Dedicated Circuits

- | | |
|---|-------------------------------------|
| - Living Room Lights | - Garage and Mudroom Lights |
| - Living Room and Hall Outlet(s) | - Master Bedroom Lights and Outlets |
| - 2nd Floor East Bedroom Lights and Outlets | - Master Bath Lighting |
| - Bathroom and Hall Lighting | - Foyer and Outdoor Lighting |
| - Kitchen Lighting | |
| - Basement Light(s) | |
| - 2nd Floor West Bedroom Lights and Outlets | |



IMPORTANT NOTES:

- Lighting loads will always remain available for all Energy Scenes.
- Phases must be balanced between Energy Scenes, otherwise phase imbalance will occur.
- For more information on Energy Scenes, see the [Energy Scene Blueprint Deployment Guide](#).

13.1. Energy Load Settings

All loads monitored and controlled by the Savant System are displayed within the Energy Load pane. Follow the steps below for all loads:

1. For loads that are **Backed Up**, **Dedicated**, or **Critical** respectively, enable the appropriate checkbox.
2. Double-click the **Max Wattage** column for each load and enter the maximum wattage the load will be capable of using while the Energy Scene is activated.

NOTE: All other settings within this pane are informational or for use within triggers.

Energy Load Pane

Filter: B C D <input type="text"/>		Energy Loads						
Zone	Name	Backed Up	Dedicated	Critical	Max Wattage	Component	State	Tolerance
Host Loads								
Room 1	Bedroom Lights	<input checked="" type="checkbox"/>	<input type="checkbox"/>	<input checked="" type="checkbox"/>	300 W	Panel Bridge Controller	CurrentDimmerLevel_3_001	
Room 1	Car Charger	<input checked="" type="checkbox"/>	<input checked="" type="checkbox"/>	<input checked="" type="checkbox"/>	1000 W	Panel Bridge Controller	CurrentDimmerLevel_2_001	
Room 1	Oven	<input checked="" type="checkbox"/>	<input checked="" type="checkbox"/>	<input type="checkbox"/>	1000 W	Panel Bridge Controller	CurrentDimmerLevel_4_001	
Room 1	Bath Lights	<input checked="" type="checkbox"/>	<input checked="" type="checkbox"/>	<input type="checkbox"/>	0 W	Panel Bridge Controller	CurrentDimmerLevel_5_001	
Room 1	PowerLink	<input checked="" type="checkbox"/>	<input type="checkbox"/>	<input checked="" type="checkbox"/>	2400 W	Panel Bridge Controller	CurrentDimmerLevel_6_001	
Room 1	Hall Lights	<input checked="" type="checkbox"/>	<input type="checkbox"/>	<input checked="" type="checkbox"/>	500 W	Panel Bridge Controller	CurrentDimmerLevel_7_001	
Room 1	LR Lights	<input checked="" type="checkbox"/>	<input checked="" type="checkbox"/>	<input checked="" type="checkbox"/>	0 W	Panel Bridge Controller	CurrentDimmerLevel_8_001	
Room 1	Dishwasher	<input checked="" type="checkbox"/>	<input checked="" type="checkbox"/>	<input checked="" type="checkbox"/>	0 W	Panel Bridge Controller	CurrentDimmerLevel_9_001	
Lighting Controllers (All lighting loads remain available in the event of a power outage)								
Room 1	Load			<input checked="" type="checkbox"/>		Keypad 3	CurrentDimmerLevel_1_005	
Room 1	Load 1			<input checked="" type="checkbox"/>		Keypad 4	CurrentDimmerLevel_1_006	
Room 1	Load 2			<input checked="" type="checkbox"/>		Keypad 5	CurrentDimmerLevel_1_007	

(A)	Filter	Filter displayed loads by Backed Up (B), Critical (C), and Dedicated (D)
(B)	Search Bar	Search for any Energy Loads by Name.
(C)	Zone	Zone the Load will be shown in the Savant Pro App.
(D)	Name	Name of the Energy Load.
(E)	Backed Up	Whether the load is backed up by a power source.
(F)	Dedicated	Check to treat the load as Dedicated.
(G)	Critical	If the load will remain accessible when the Power Grid is unavailable.
(H)	Max Wattage	Maximum wattage the load can use.
(I)	Component	Which Panel Bridge Controller is controlling the load.
(J)	State	State the load will report to for useage in triggers.
(K)	Tolerance	Temperature tolerance for thermostats only.

14. Upload Configuration

With the configuration complete, it can now be saved and uploaded to the Savant System Host.

⚠ IMPORTANT! When connected to the OLA Server, all control to the Savant System is lost. Close the OLA Server window before uploading a configuration to the Host.

1. Select the **Generate Services** icon from the Blueprint tool bar. The **State** Icon will change to either blue or green indicating that all realized services are up to date with configuration changes.
2. Select Update **All UI Screens > Sync with Services** (only if necessary) to sync the user interfaces such as an iPad to the services created. The State Icon will switch to Green when complete.
3. To upload configuration to the Host, select the **Upload to Master** icon from the Blueprint tool bar. See image below.

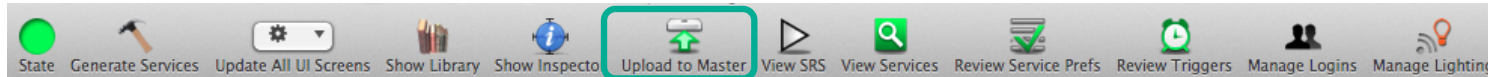

Select Upload to Master

4. In the **Configuration must be saved** dialog box that opens, read the dialog and select **Save and Upload**.

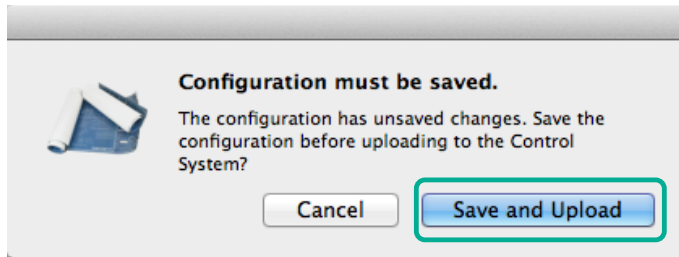

5. The System Monitor application will open as displayed below. Verify the path to the configuration file is correct. Select **Upload** when satisfied. Configuration will now upload to the Host.

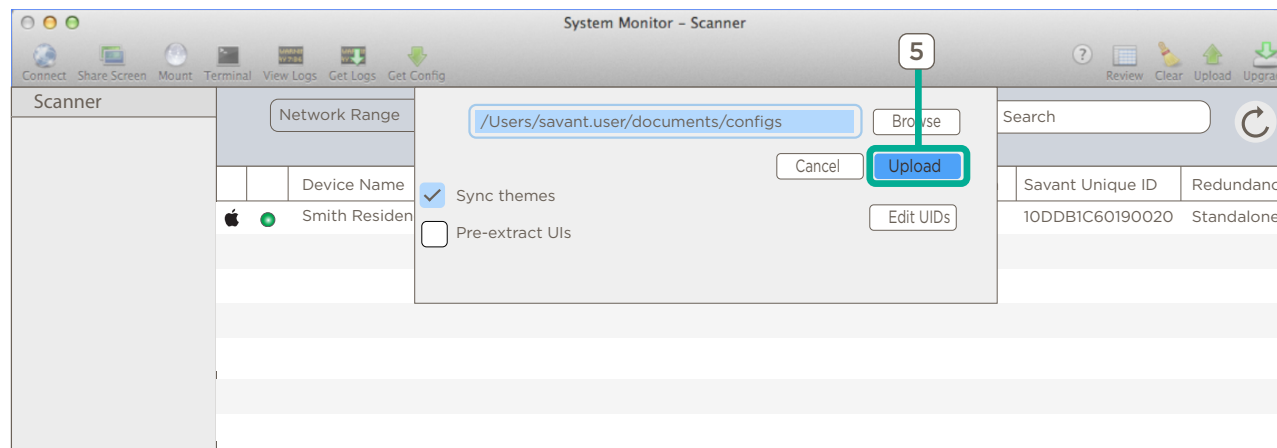

Appendix A: Savant Power Module PAIR Button Functions

The PAIR button on Savant Power Modules has multiple functions depending on the length of time pressed.

- To cycle through options, tap the PAIR button.
- To select an option, hold the PAIR button for 1 second.
- To clear pairing, hold the PAIR button for 3 seconds until the Gear icon appears.
- To reset the Savant Power Module, hold the PAIR button for 5 seconds.

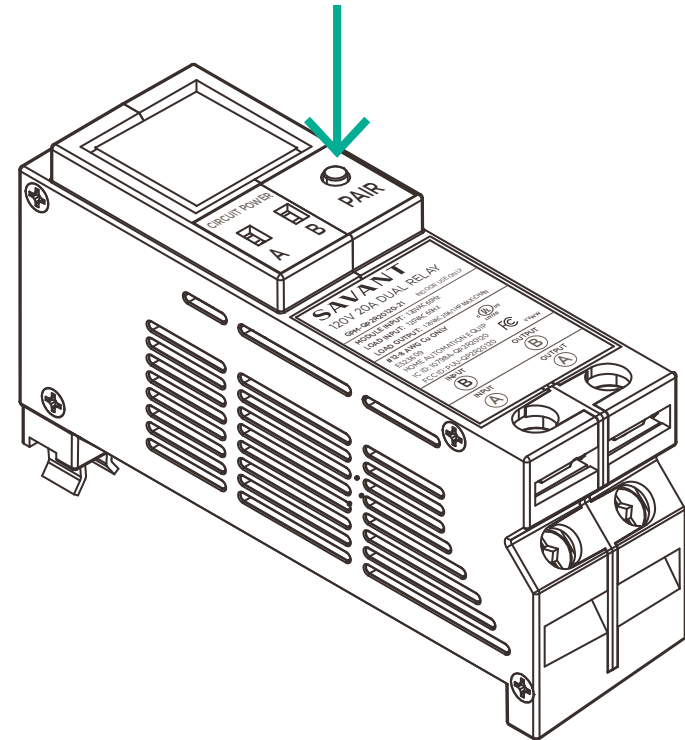

Appendix C: On-Device Setup

Savant Power Module room, name, and slot number can be set by configuring the Savant Power Module using the PAIR button. This process can only be done if the the Power & Lighting App is being used to pair Savant Power Modules. See [Appendix A: Savant Power Module PAIR Button Functions](#) for more information.

NOTE: New Savant Power Modules will have no names and begin at step 2.



- 1 TAP AND HOLD PAIR BUTTON FOR 5 SECONDS TO CLEAR SETTINGS

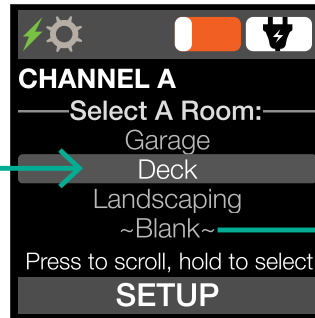

- 2 TAP PAIR TO BEGIN PRE-APP SETUP. SELECT THE ROOM FOR CHANNEL A



- 3 SELECT CIRCUIT NAME FOR CHANNEL A

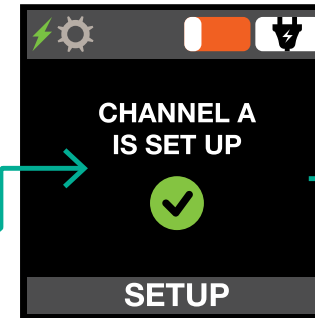

- 4 CHANNEL A IS CONFIGURED

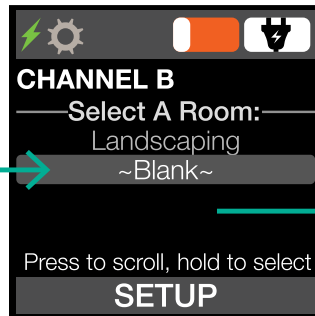

- 5 SELECT ROOM FOR CHANNEL B

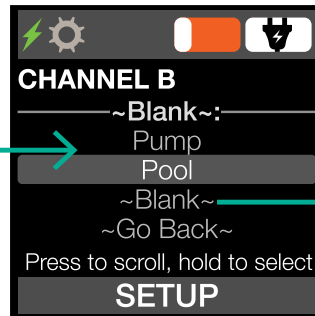

- 6 SELECT CIRCUIT NAME FOR CHANNEL B

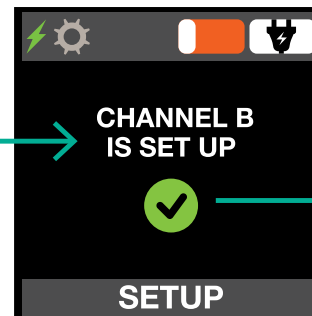

- 7 CHANNEL B IS CONFIGURED

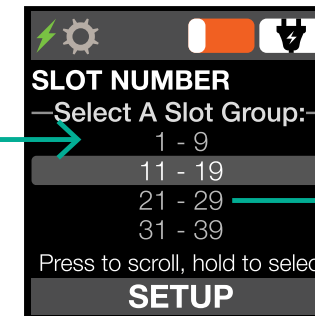

- 8 SELECT SLOT GROUP

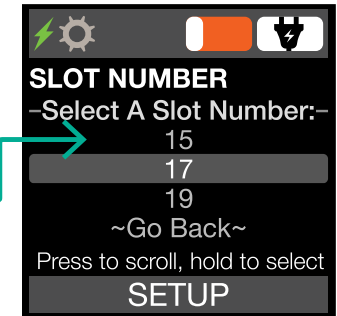

- 9 SELECT SLOT NUMBER

Appendix D: Savant Power & Light App Setup

In order to use the Savant Power & Light during the deployment of an Savant Power System, a Power & Light Home must be setup. The Savant Power & Light app can be used for replacement of OLA to onboard Savant Power Modules and pairing and naming Savant Power Modules.

IMPORTANT NOTES:

- Before completing Savant Power & Light App setup, complete **On-Device Setup**.
- All other configuration setup must be done in Blueprint if configuring a Savant Home.

Home Setup

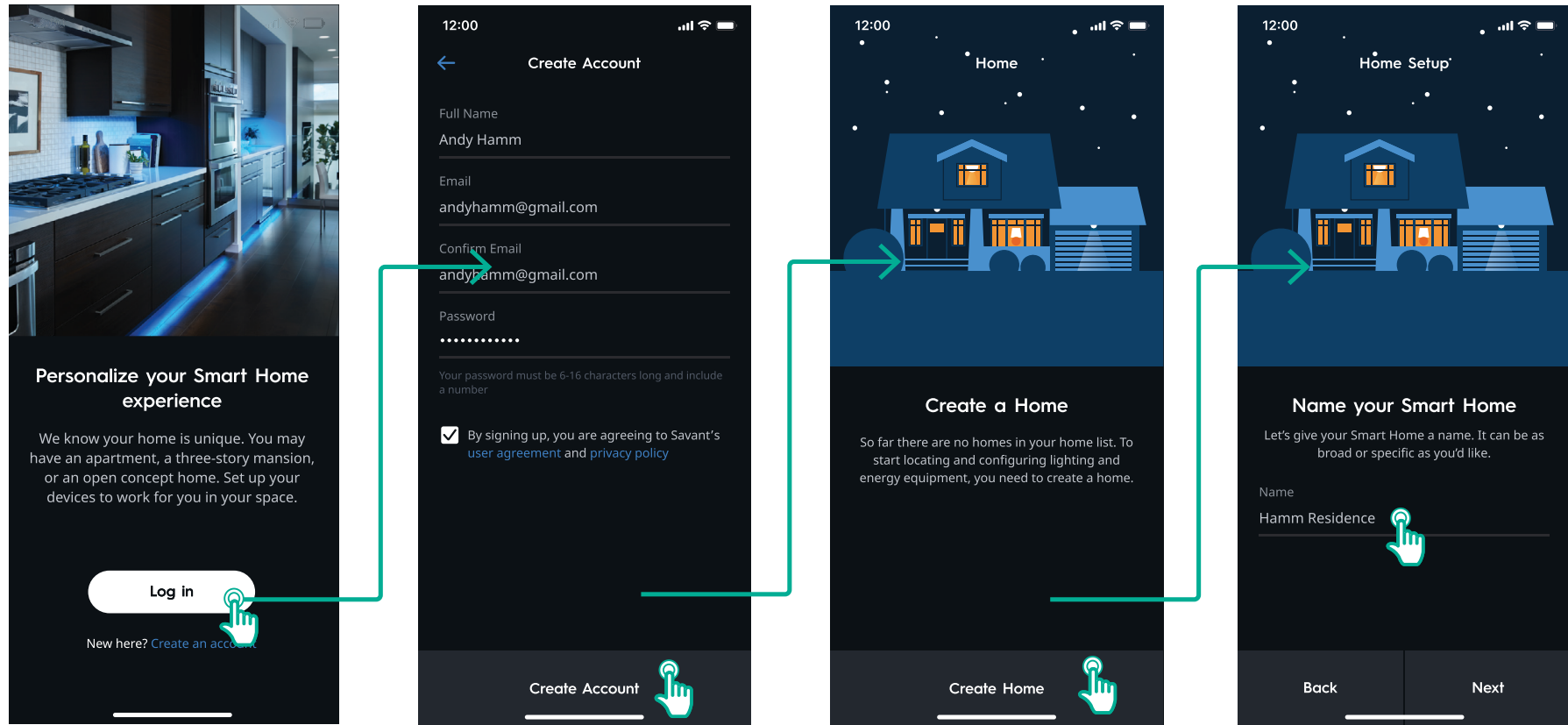

1 TAP CREATE AN ACCOUNT OR LOG IN WITH AN EXISTING ACCOUNT

2 FILL IN ACCOUNT DETAILS AND AGREE TO THE USER AGREEMENT BEFORE TAPPING CREATE ACCOUNT

3 TAP CREATE HOME

4 NAME THE HOME AND TAP NEXT.

Add Photo

The Savant Home is represented within the Savant Power & Light app with a name and image.

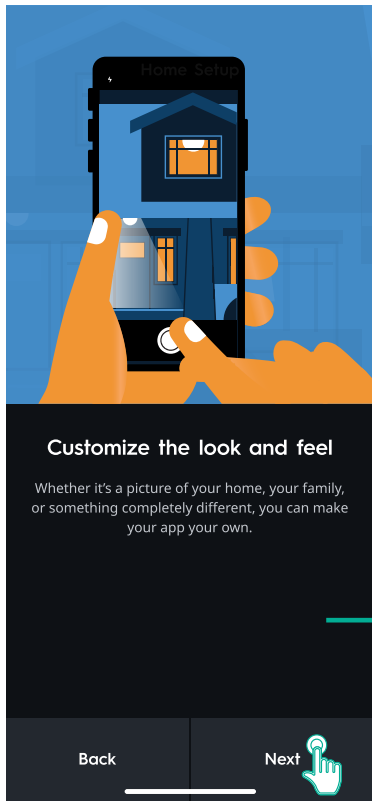

1 TAP NEXT

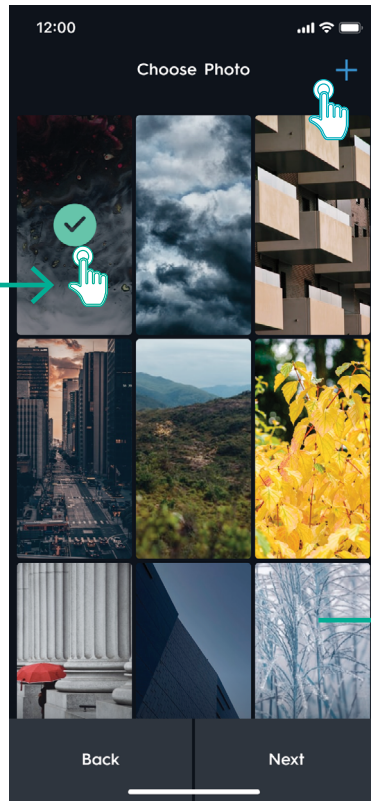

2 SELECT AN IMAGE FROM THE ARRANGED PHOTOS

OR

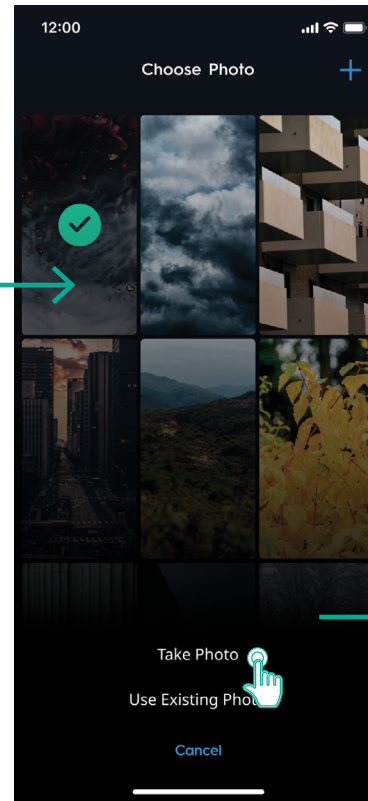

TAP THE PLUS SIGN TO TAKE A PHOTO OR USE AN EXISTING PHOTO



3 TAP USE PHOTO OR CHOOSE

Appendix E: Device Discovery

The Savant Power & Light app can scan for all Energy and Lighting devices, including Host and Savant Power Modules configured in [On-Device Setup](#).

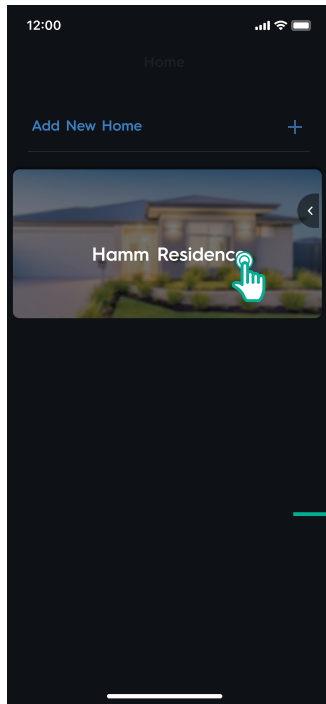

1 TAP ON THE HOME

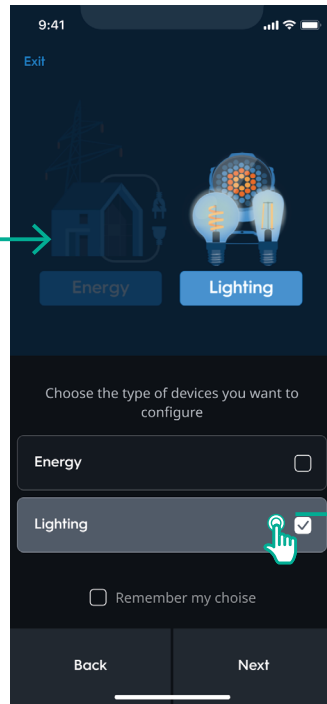

2 SELECT LIGHTING DEVICES AND TAP NEXT.

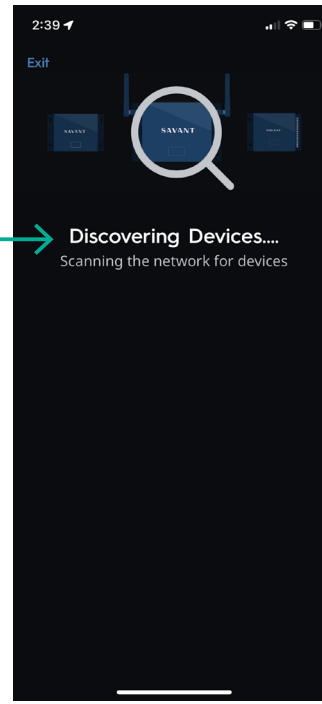

3 THE POWER & LIGHT 2.0 APP AUTOMATICALLY SCANS FOR ALL DEVICES ON THE NETWORK.

Appendix F: Dashboard

The Dashboard appears after all devices have been discovered, or when the Savant Home is selected after initial deployment. The Energy Dashboard is an overview of all configured power sources, loads, Energy Scenes and breaker panels.

Dashboard

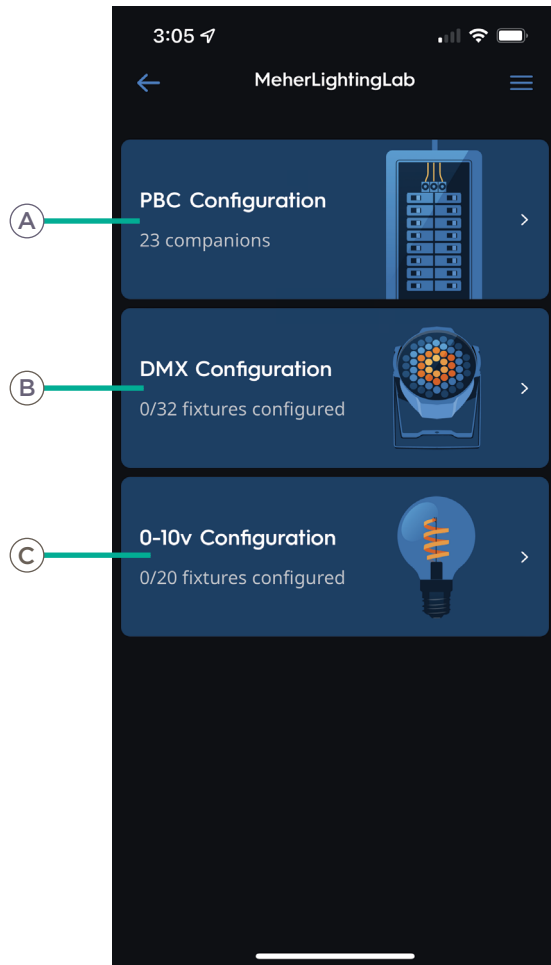

A	PBC Configuration	Quantity of Savant Power Modules. Tap to configure Savant Power Modules for Lighting.
B	DMX Configuration	Number of fixtures configured. Tap to configure DMX controller and any wired fixtures.
C	0-10v Configuration	Number of 0-10v fixtures configured. Tap to configure any discovered 0-10v controllers and fixtures.

Appendix G: Get Config

A **Config** is a file that contains all Savant Power Modules, breakers, their slots, power sources, and associated settings.

⚠ IMPORTANT!: The initial config must be downloaded from the Host to the Savant Power & Light app before making any changes or continuing deployment.

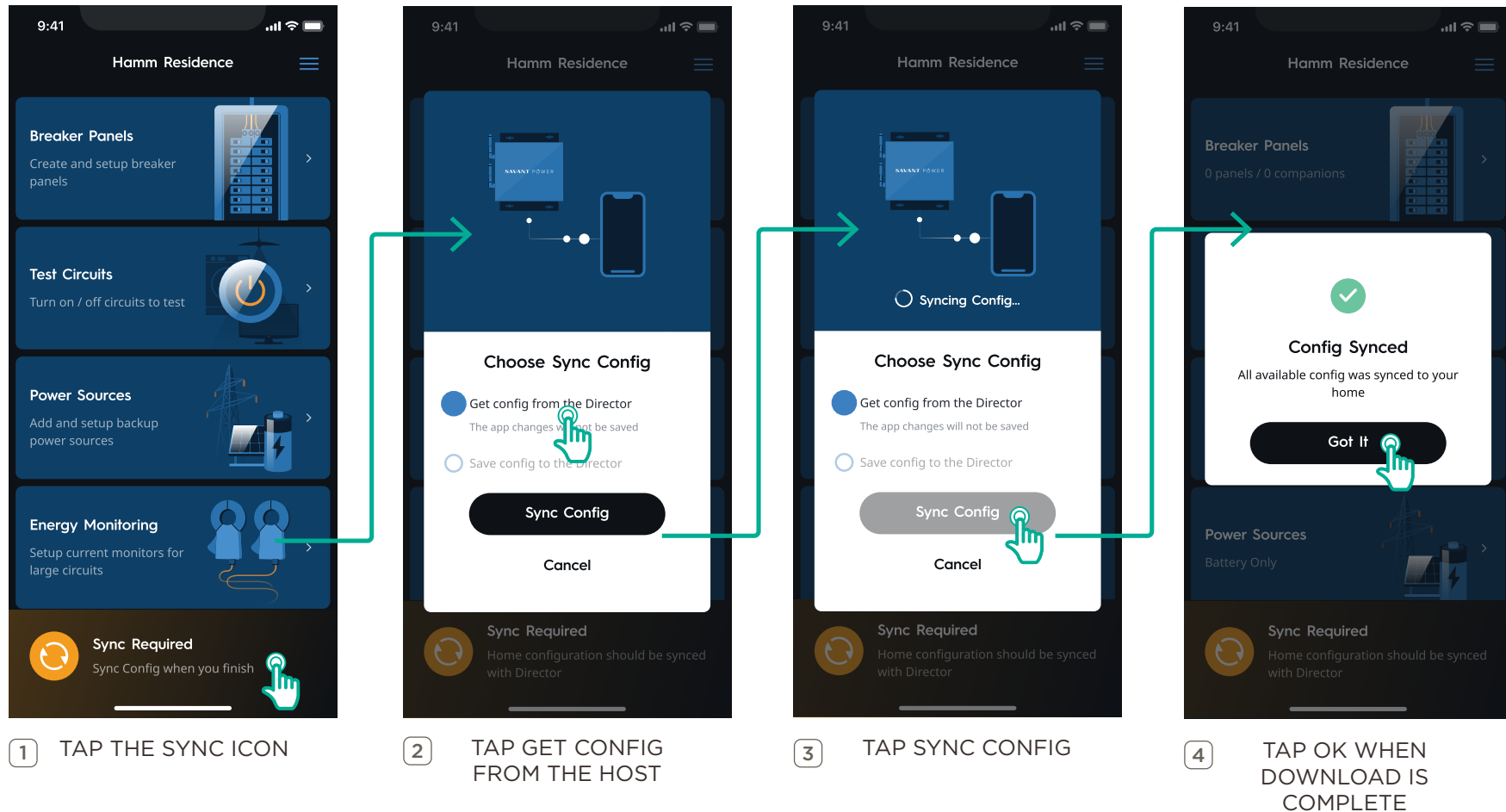

Appendix H: Test Circuits

With the Config uploaded to the Power & Light app, test the functionality of the Savant Power Modules and their associated circuits before continuing deployment.

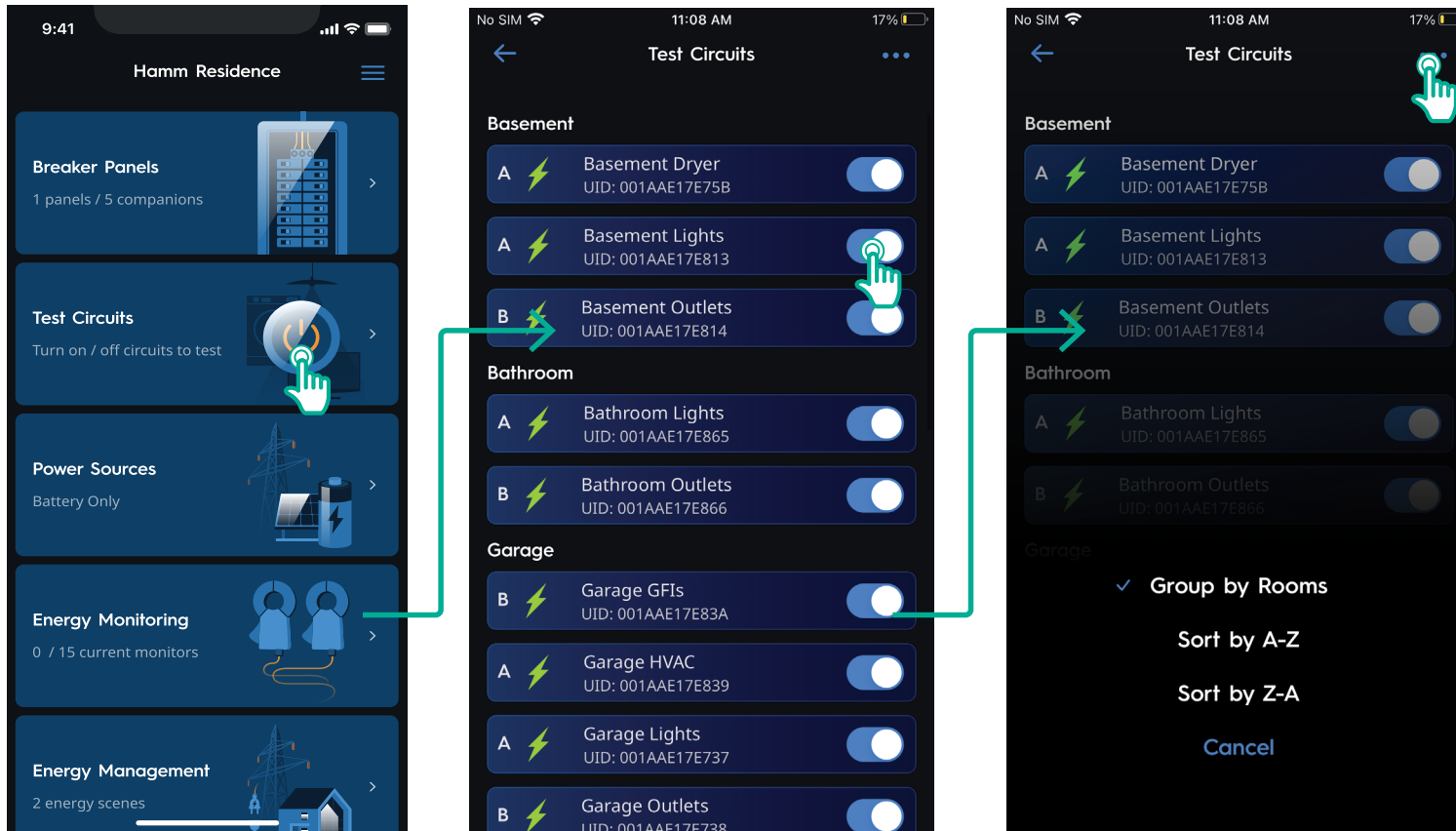

1 ON THE HOME SCREEN, TAP TEST CIRCUITS

2 TAP THE TOGGLE SWITCH TO TURN INDIVIDUAL LOADS ON OR OFF

3 TAP THE ... ICON TO SORT CIRCUITS ALPHABETICALLY OR BY ROOM

Appendix I: Add Breaker Panel

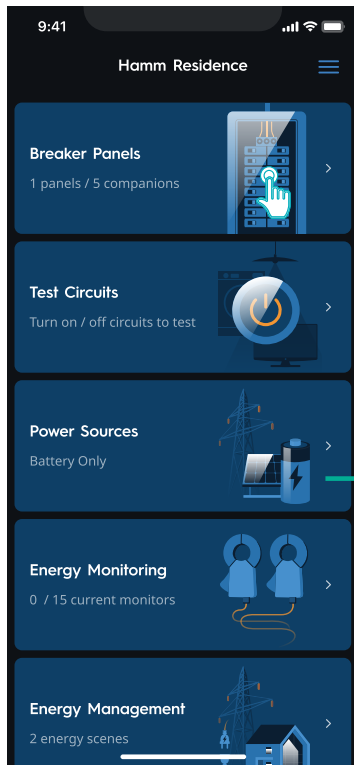

1 TAP BREAKER PANELS

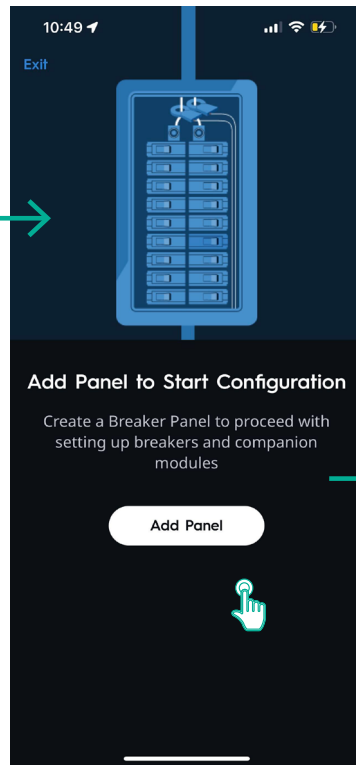

2 TAP ADD PANEL

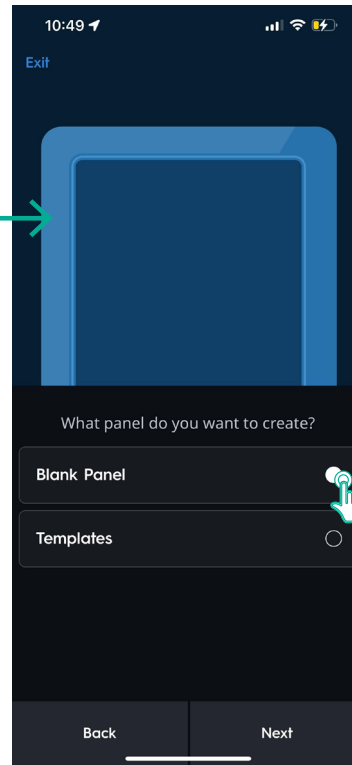

3 SELECT EITHER BLANK PANEL, OR TEMPLATES

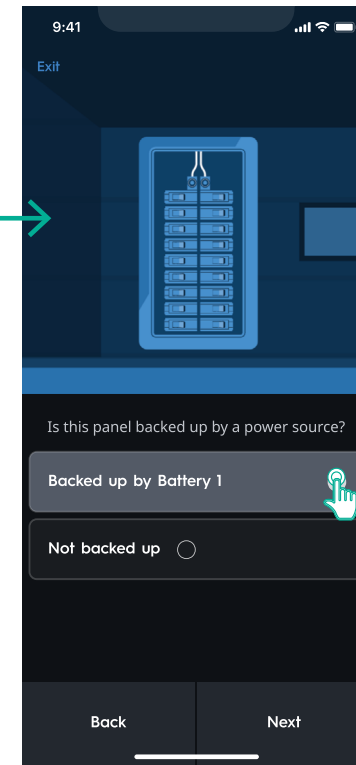

4 CHOOSE WHICH POWER SOURCE WILL PROVIDE BACKUP POWER WHEN THE GRID IS UNAVAILABLE

Appendix J: Pair Modules

Modules must be paired or associated prior to syncing the configuration to the Host. Skip this section if [On-Device Setup](#) has been completed.

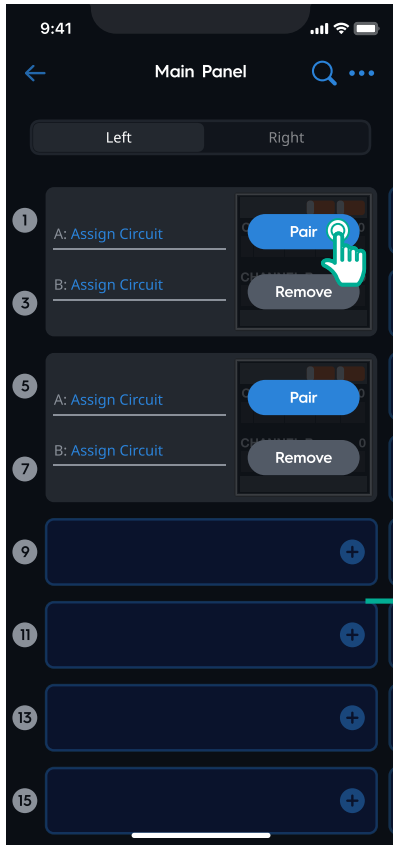

1 TAP PAIR

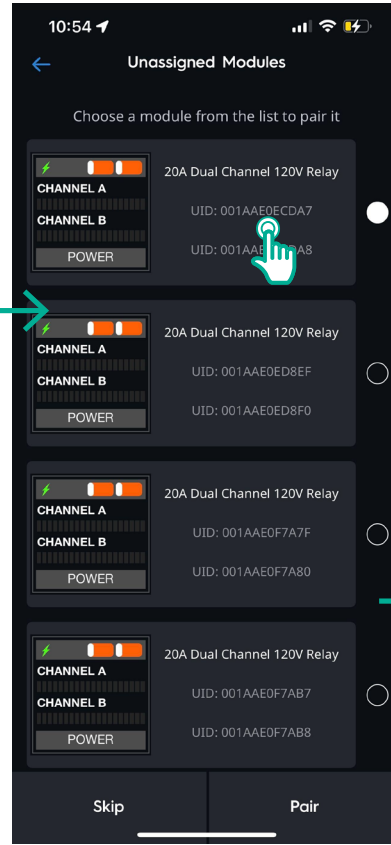

2 SELECT THE MODULE AND TAP PAIR

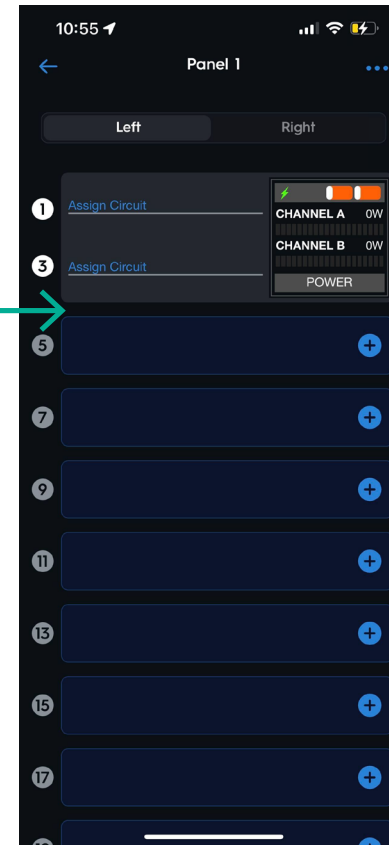

3 THE MODULE WILL DISPLAY A BLUETOOTH ICON WHEN PAIRED

Appendix K: Lighting

Lighting Configuration can be begun within the Savant Power & Light app. When all steps within this appendix have been completed, refer to the Panelized Lighting Deployment Guide for Appendix

Add Panel (Panel Bridge Controller Only)

The process for adding a breaker panel for a Panel Bridge Controller is the exact same process as stated in [Appendix I: Add Breaker Panel](#), except accessed by tapping **PBC Configuration**.

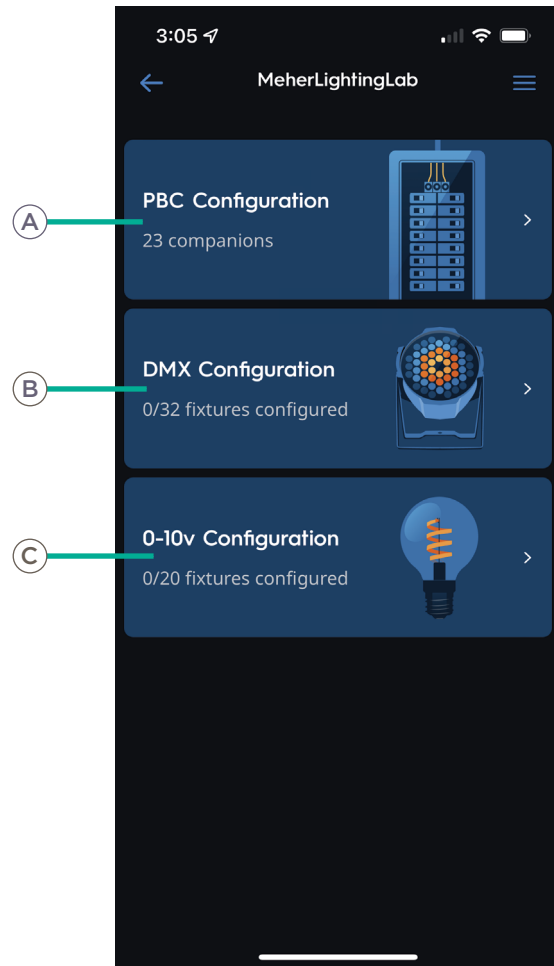

(A)	PBC Configuration	Quantity of Savant Power Modules. Tap to configure Savant Power Modules for Lighting.
(B)	DMX Configuration	Number of fixtures configured. Tap to configure DMX controller and any wired fixtures.
(C)	0-10v Configuration	Number of 0-10v fixtures configured. Tap to configure any discovered 0-10v controllers and fixtures.

DMX and 0-10V Discovery

The Savant Power & Light app allows for quick discovery of DMX and 0-10 controllers and wired DMX fixtures connected to them. For more information on DMX and 0-10V, see the **DMX and 0-10V Lighting Deployment Guide [da Vinci 9.0 and higher]** guide on the Savant Community.

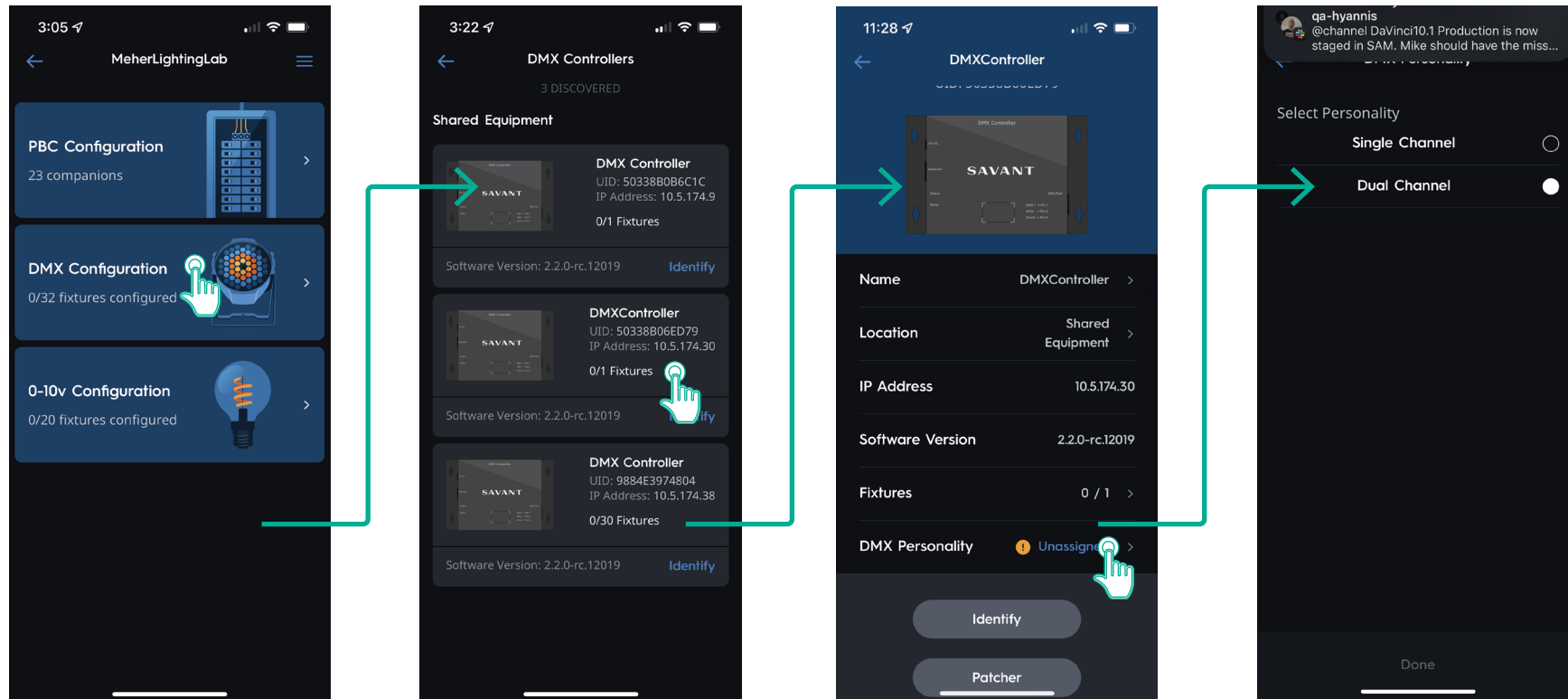

1 TAP DMX OR 0-10V CONFIGURATION

2 TAP IDENTIFY TO FLASH ALL LIGHTS WIRED TO THE CONTROLLER. THEN TAP ON THE CONTROLLER

3 TAP ON THE FIELDS TO CONFIGURE THE CONTROLLER

4 (DMX ONLY) TAP DMX PERSONALITY AND CHOOSE DUAL OR SINGLE CHANNEL

Discover and Configure Fixtures

All fixtures wired to the DMX or 0-10V controller can be discovered and configured using the Savant Power & Light app.

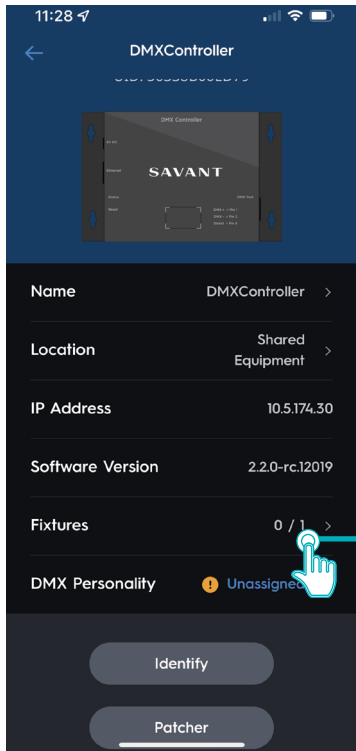

1 TAP FIXTURES

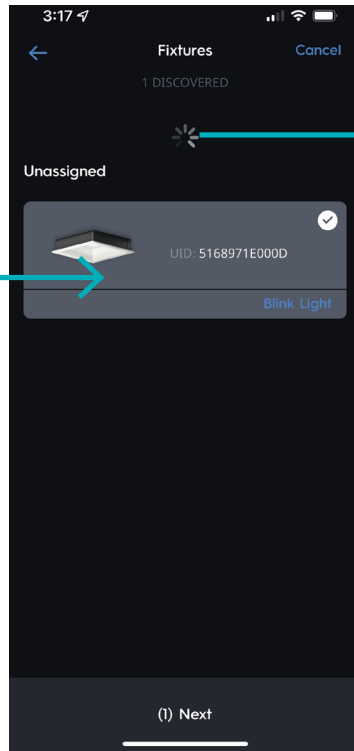

2 SWIPE DOWN ON THE FIXTURES SCREEN TO DISCOVER ALL WIRED LIGHTS

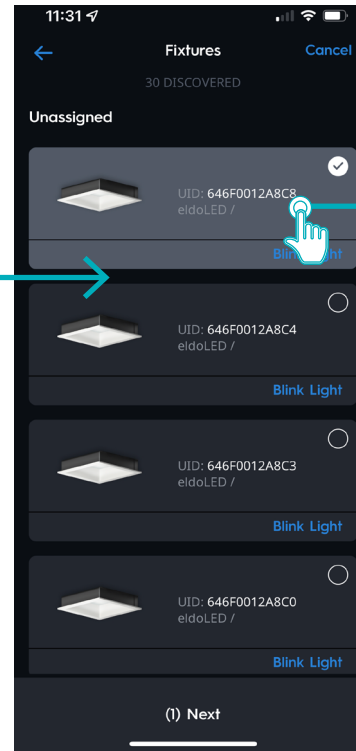

3 ALL WIRED LIGHTS WILL APPEAR HERE. HIGHLIGHT THE FIXTURES TO BE CONFIGURED AND TAP NEXT

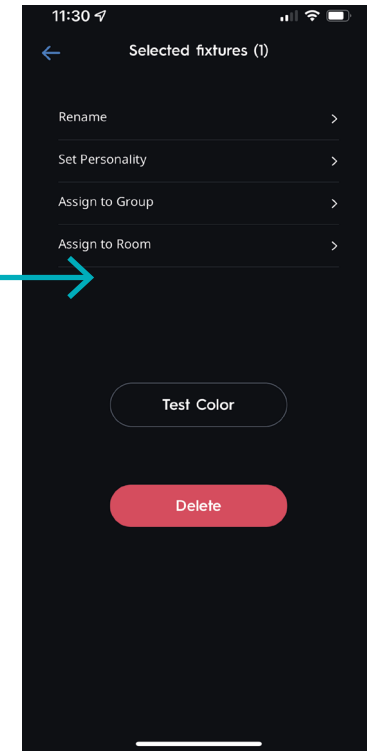

4 RENAME, SET PERSONALITY AND GROUP THE FIXTURES HERE.

Test Colors

Before uploading the configuration to the Host, it is important to ensure the functionality and responsiveness of all lighting fixtures.

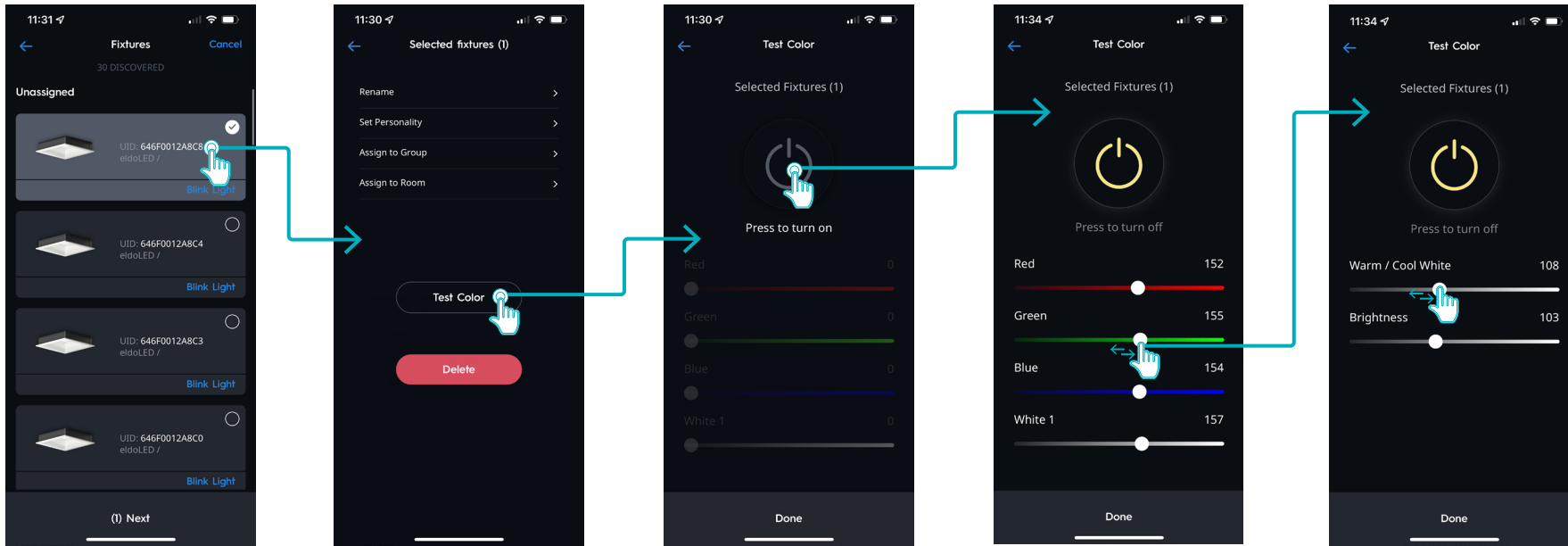

Appendix L: Save Config to Host

Once all changes have been made to the configuration, it must be uploaded to the Host.

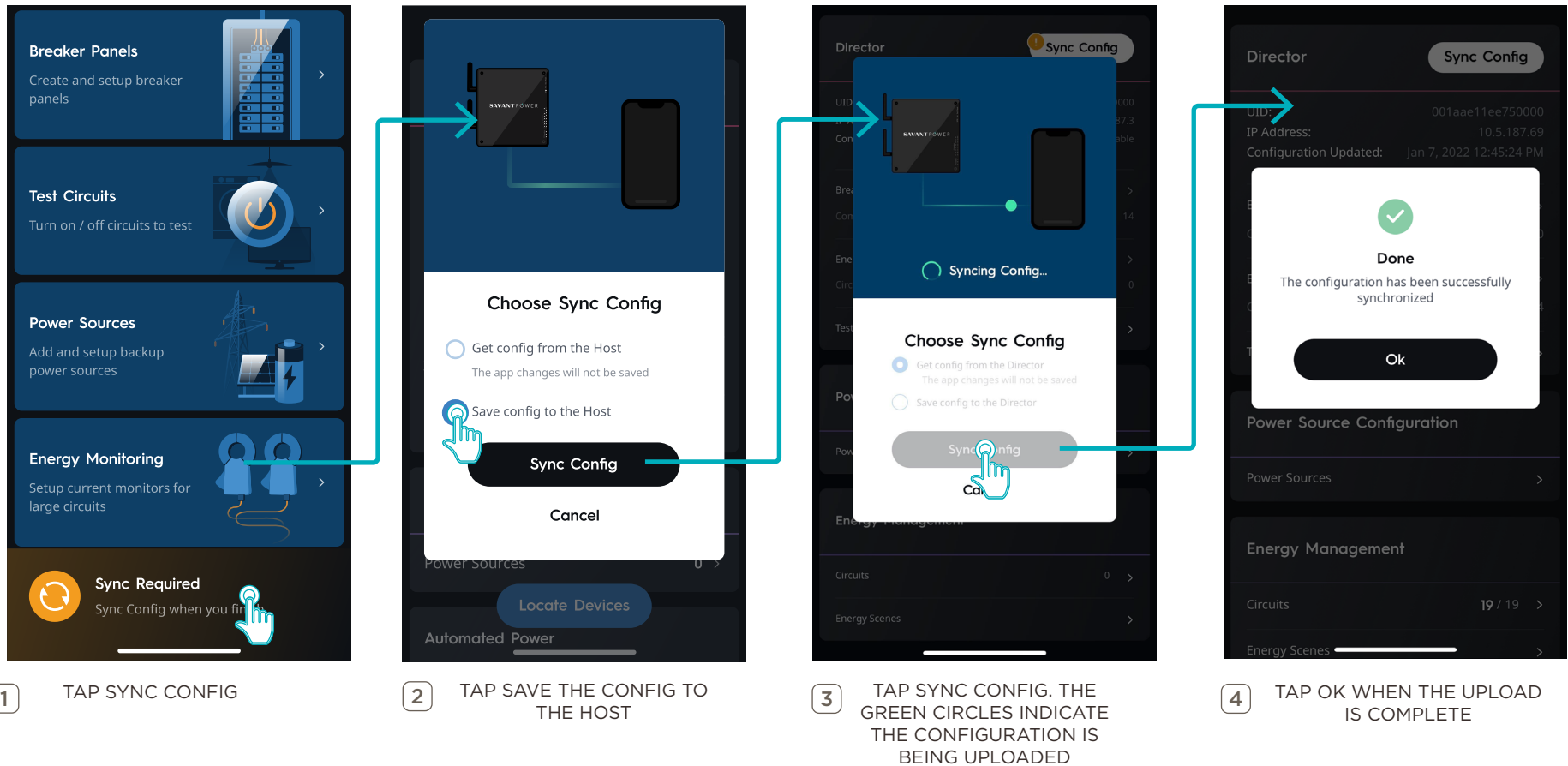

NOTE: Once the Savant Power & Light configuration has been uploaded to the PBC or Lighting Controller, Blueprint needs to be used for the rest of the configuration. Start at [Section 8](#), skipping Section 10 to complete the rest of the Savant Power System configuration.

Appendix M: System Information Checklist

This page is used to record all important information for the installation.

Site Information

Date of Deployment:

Site WiFi SSID:

Site WiFi Password:

Schneider Information

WiFi Password:

MAC Address:

Serial Number:

Software Version:

MFG:

Fortress Information

Battery Install Date:

Savant Information

Bootloader:

Firmware Version:

Savant Power & Light Build:

Savant Pro app Version:

NOTES:

Important Notice

Disclaimer

Savant Systems, Inc. reserves the right to change product specifications without notice, therefore, the information presented herein shall not be construed as a commitment or warranty.

Savant Systems, Inc. shall not be liable for any technical or editorial errors or omissions contained herein or for incidental or consequential damages resulting from the performance, furnishing, reliance on, or use of this material.

Patents

Certain equipment and software described in this document is protected by issued and pending U.S. and foreign patents.

All products and services are trademarks or registered trademarks of their respective manufacturer.

Copyright

This document contains confidential and proprietary information protected by copyright. All rights reserved. Copying or other reproduction of all or parts of this document is prohibited without the permission of Savant Systems.

Trademarks

© 2022 Savant Systems, Inc. All rights reserved. Savant, Savant app, TrueImage, Savant Host, Now You Can, RacePoint Blueprint, Single app Home, TrueCommand, TrueControl, and the Savant logo are trademarks of Savant Systems, Inc.

AirPlay, apple, AirPort Express, AirPort Extreme, apple TV, apple Remote Desktop, FireWire, iMac, iTunes, iPad, iPad mini, iPad Air, iPhone, MacBook, Mac and OS X are trademarks or trade names of apple Inc. iOS is a trademark of Cisco®. Android, Google, Google Play, and other Google marks are trademarks of Google, Inc. Wi-Fi is a registered trademark of the Wi-Fi Alliance®, HDMI® is a trademark of HDMI Licensing, Inc. MOTU® is a registered trademark of Mark of the Unicorn, Inc. Luxul is a registered trademark of Luxul Wireless. NETGEAR®, the NETGEAR Logo and ProSAFE are trademarks of NETGEAR, Inc. Extreme™ is a trademark of Extreme Networks, Inc.

All other brand names, product names, and trademarks are the property of their respective owners.

Technical and Sales Support

Savant Power, Inc. is dedicated to providing prompt and effective support in a timely and efficient manner.

- To contact Savant Power Support, access the [Savant Customer Community](#) and enter a support Case ticket.
- To contact Savant Sales, visit Savant.com and select Contact Us to locate a local sales representative in your area.