

SAVANT

Savant® Stand Alone Energy Monitor (SEM-2015) Quick Reference Guide



Box Contents

- (1) Stand Alone Energy Monitor
- (1) Install Kit (075-0227-xx)
 - (1) Universal Din Rail Mounting Clip (015-0255-xx)
 - (1) Power Supply (025-0192-xx)
 - (1) 6-Pin Screw Down Connector (028-0664-xx)
 - (15) 2-Pin Screw Down Connector (028-0884-xx)
 - (4) #6x1/4 PH Flat Screws (039-0143-xx)
- (1) Product Regulatory Insert (009-1950-xx)

Accessories (sold separately)

- SEM-VT01 - SmartEnergy Voltage Sensor
- Split Core Current Transformers (Clamp-on) with 8ft leads.
 - SEM-020A5 20 Amps 5 Pack
 - SEM-050A5 50 Amps 5 Pack
 - SEM-150A1 150 Amps 1 Pack
 - SEM-150A5 150 Amps 5 Pack
 - SEM-250A1 250 Amps 1 Pack
 - SEM-400A1 400 Amps 1 Pack
 - SEM-600A1 600 Amps 1 Pack

Specifications

Environmental	
Temperature	32° to 104° F (0° to 40° C)
Humidity	10% to 90% Relative Humidity (non-condensing)
Dimensions and Weight	
	Device Shipping
Height	1.6 in (4.06 cm) 3.3 in (8.38 cm)
Width	5.5 in (14.01 cm) 9.7 in (24.64 cm)
Depth	5.9 in (14.97 cm) 9.5 in (24.13 cm)
Weight	1.9 lb (0.8 kg) 3.3 lb (1.5 kg)
Power	
Input Power	5V DC
Nominal Power	3W (10W max)
Regulatory	
Safety and Emissions	FCC Part 15B  CE Mark 
RoHS	Compliant
Minimum Support Requirements	
Software Release	da Vinci 9.1

Important Information

- All wiring in the United States must be installed in accordance with the latest adopted edition of the National Electrical Code (ANSI/NFPA 70, NEC).
- All wiring in Canada must be installed in accordance with the latest adopted edition of the Canadian Electrical Code (CSA C22.2 CEC, Part 1) and any provincial or local requirements.
- Savant's largest Current Transformer supports wire up to 500 MCM (this with jacket is just under 1 inch).

-  **TIP!** MCM refers to circular mils and is often used for wire larger than the AWG measurement accommodates.
- Maximum length for leads on each current transformer should not exceed 8 feet. Longer lengths will cause inaccurate readings.
- If required, the leads on the current transformers can be shortened.

Left Side Panel

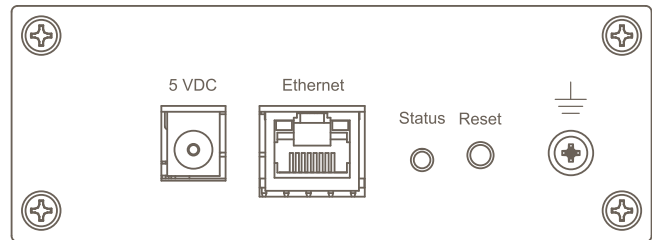

5 VDC	Power Input - Connect the supplied power adapter between the 5V DC port and a surge protected (120-240V AC, 50/60 Hz) outlet.
Ethernet	8-Pin RJ 45 port. 10/100/1000 BaseT auto-negotiating port with link activity LEDs
Status	Blinking Red - Embedded firmware is running but has not received an IP Address. Solid Green - Connected to the local network and communicating with the Savant System Host.
Reset	Press and release to perform a hard reset. Status LED will illuminate while button is pressed. Device Reset: 1. Disconnect power. 2. Reconnect power while holding the reset button for 40 seconds. Device will reboot clearing its configuration and resetting its password.
 (Ground)	Chassis Ground (optional)

Right Side Panel

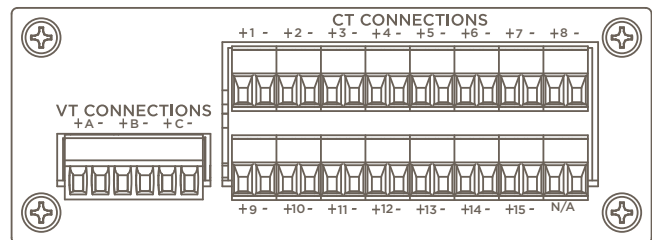

VT Connections	Voltage Transformer - (3) Voltage sensor input ports. Input port for the SEM-VT01 voltage sensor.
CT Connections	Current Transformer - (15) Input ports for each Current Transformer installed in the system.

Mounting

The SEM-2015 can be mounted to either a wall or similar using the pre-installed Mounting Bracket and the included #6x1/4 PH Flat Screws. Also the device can be mounted to a Universal Din Rail by removing the Mounting Bracket and attaching the included Universal Din Rail Clip on the bottom of the device. For more information on mounting see the Standalone Energy Monitor Deployment Guide on the [Savant Customer Community](#).

Current Transformer Input Polarity

Current Transformer Input

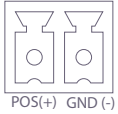

POS (+) - White or red wire from Current Transformer
GND (-) - Black wire from Current Transformer

Install Current Transformers

- ⚠ SAFETY CAUTIONS!** Before beginning the installation process, read through the following precautions.
- The installation of a Current Transformer requires making connections within an electrical panel. Savant recommends that a licensed electrician perform the installation.
 - The install should obey all local electrical codes.
 - Only Current Transformers offered from Savant are supported. These CT's are internally shunted and safer than other commercially available Current Transformers

Connecting Current Transformers

Follow instructions below when installing the current transformers into an electrical breaker panel.

1. Remove power from electrical panel by switching the main breaker to the Off position.
2. Remove the electrical panel front cover and set aside. With a voltage tester, verify power was removed to the individual breakers.
3. Install the Current Transformers over each conductor being monitored. Depending on the current transformer being used will determine how it is installed. See below.

20 and 50 Amp Current Transformers

- A. Pry the clip on the side of the Current Transformer away from the housing and hinge open the Current Transformer.
- B. Position the conductor being measured into the opening of the Current Transformer. Close the Current Transformer ensuring the clip on the side snaps into place.

- ⚠ IMPORTANT!** To observe proper polarity, install the 20 and 50A current transformers with arrows pointing in the direction of current flow (towards the load).

- C. Route the wire through a cable clamp on the side of the panel and run wire to the SEM-2015 chassis.

150 Amp Current Transformers

- A. Squeeze the handle on side of Current Transformer until the opposite end opens.
- B. Position the open end of Current Transformer over the conductor and release the handle so the wire settles inside the opening of Current Transformer.

- ⚠ IMPORTANT!** To observe proper polarity, install the 150A or larger current transformers with the label on the Current Transformer facing the source of the power.

- C. Route the wire through a cable clamp on the side of the panel and run wire to the SEM-2015.
4. Following steps below, install the supplied 2-pin screw down connector onto the wires of each Current Transformer.
 - A. With a small slotted screwdriver, turn the screws on the connector counterclockwise (CCW) until the silver crimps open enough to slide the stripped wire into the square slots.
 - B. Strip back insulation on each wire to 1/4 inch and insert the stripped wire into proper connection. See the Current Transformer and Voltage Sensor Input Polarity section for polarity information.
 - C. Turn screws clockwise (CW) until the crimps tighten around each wire. Tug on wire a bit to verify they are secure. Continue until all Current Transformers have a connector added to it.
 5. Plug the connector into the appropriate Current Transformer input on the SEM-2015.
 6. Replace the breaker panel front cover once all Current Transformers are installed.
 7. Switch main breaker to the ON position.

Voltage Transformer

The SEM-VT01 is a highly accurate voltage transformer that reduces the input voltage by a factor of .001. For example, if the input voltage is 120V AC, the output of the SEM-VT01 will be .120V AC. By reducing the voltage, the SEM-2015 can monitor individual circuits with exceptional accuracy.

Important Information!

- One voltage transformer is required for each phase.
- Install SEM-VT01 voltage sensor as close as possible to the electric breaker panel.
- Between the voltage transformer and the SEM-2015 it is best to have as short a run as possible.
- Voltage transformers should be installed on their own breakers with no load attached.

Install Voltage Transformer

Savant requires a licensed electrician be used to connect the SEM-VT01 to the high voltage side. Follow instructions below to install. The instructions assume the electrical outlet boxes are mounted and an electric circuit is run into the box.

1. Switch the circuit breaker to the circuit that the SEM-VT01 is being added to.
2. Using diagram below, make high voltage connections.

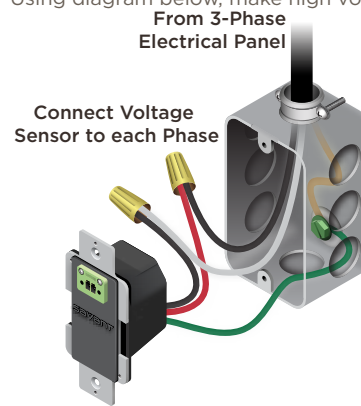

3. Screw the SEM-VT01 into the electrical box.
4. Using the supplied 2-pin screw down connectors and #18 AWG wire, install the wires into the 2-pin connector. Refer to the connector diagrams below when wiring.
5. For instructions on how to install wires into the 2-pin connectors, refer to step 4 of the Install Current Transformers section.

VT Connector on SEM-VT01

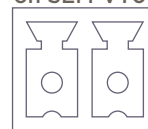

GND (-) POS (+)

VT Connector on SEM-2015

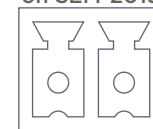

POS (+) GND (-)

6. Once all connections are made, switch the breaker back ON.
7. With the SEM-2015 and any optional accessories installed, the system can now be configured in its own Web UI. For more information see the Savant Stand Alone Energy Monitor Deployment Guide on the Savant Customer Community.

i HELPFUL INFO: Each voltage transformer is capable of supporting up to three SEM-2015 units, provided the following requirements are met:

- SEM-2015 units must be connected in a daisy chain pattern.
 - Wiring used must be 18 AWG or greater twisted pair.
 - Total run length must not exceed 8 ft (2.4 m).
- Additional voltage transformers must be utilized when deploying more than 3 SEM-2015 units.

Single Phase System (Typical 200 Amp Service)

The diagram below should be used as a reference when making connections.

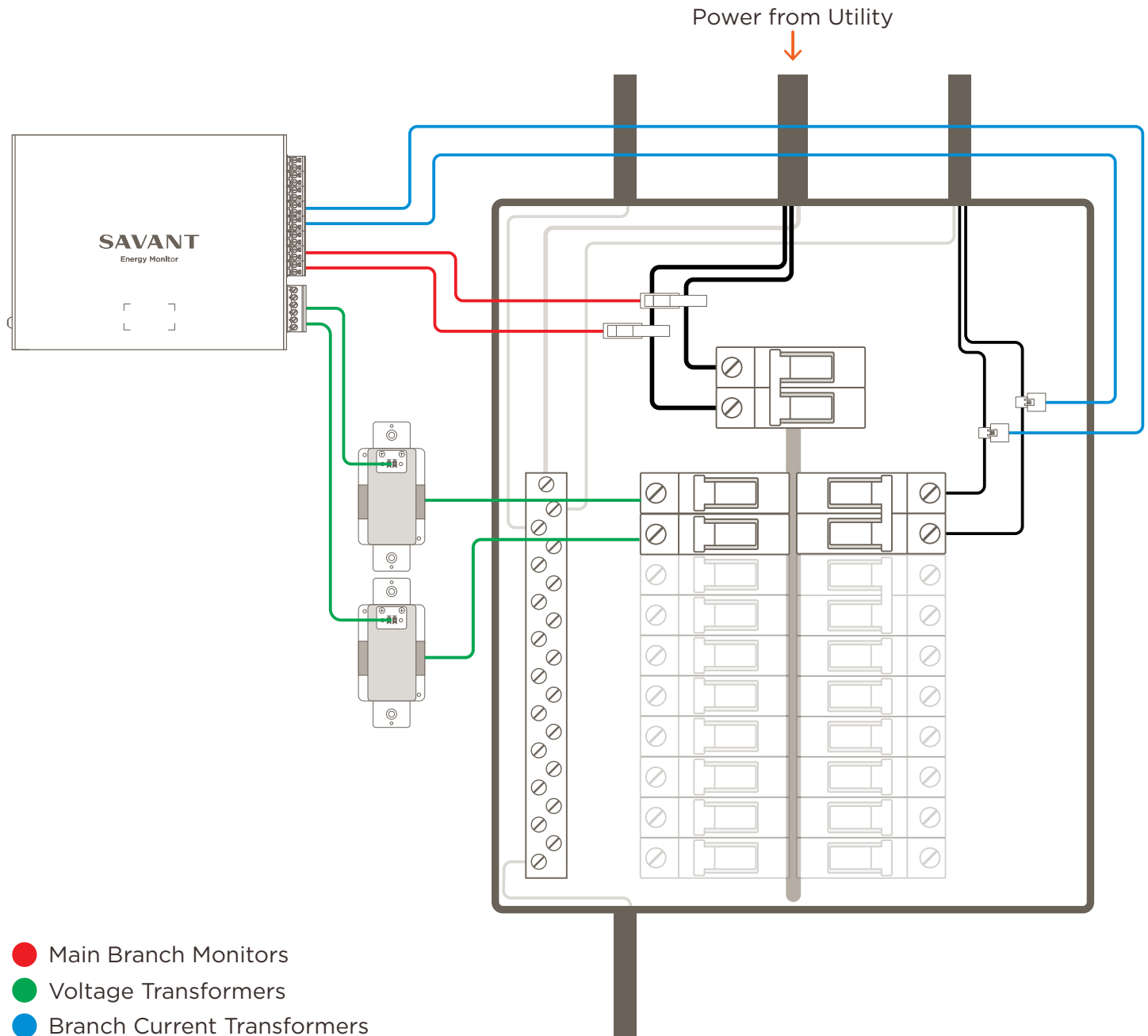

Three Phase System

The diagram below should be used as a reference when making connections.

