

XW Pro Multi-unit Design Guide

990-91373A

April 2021

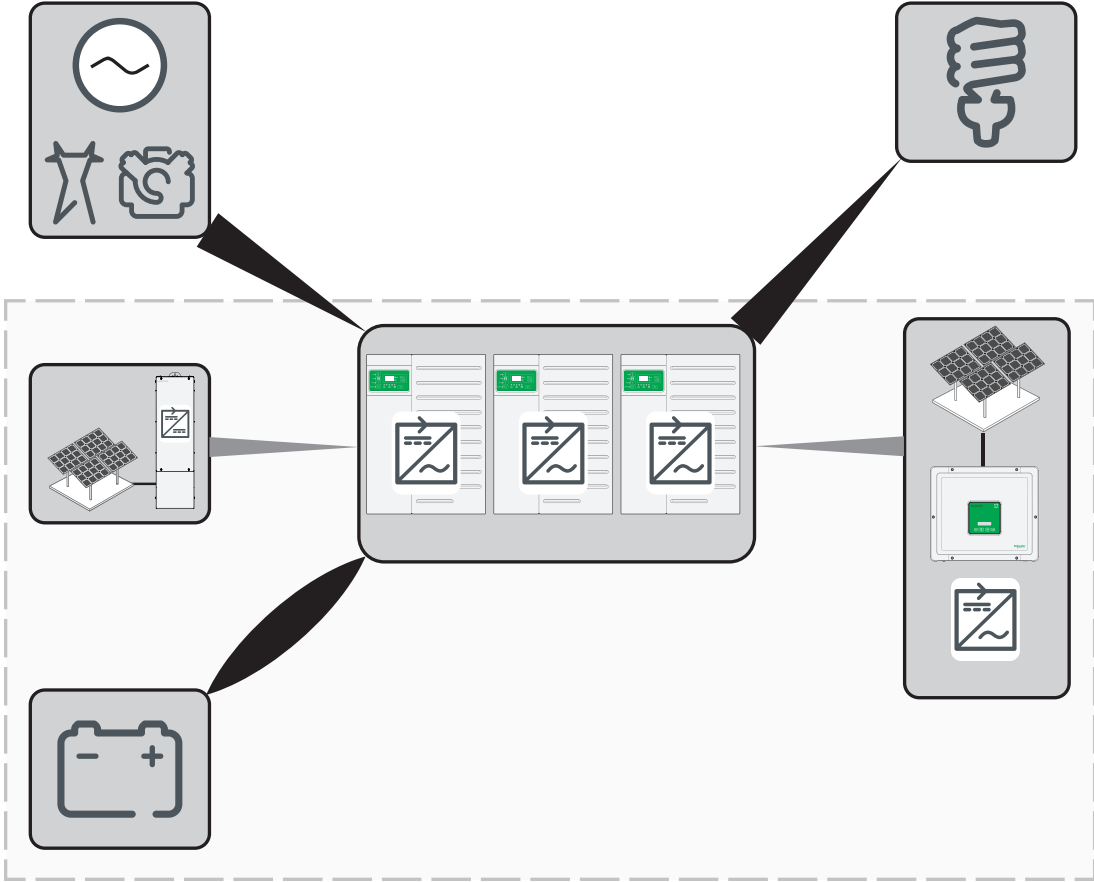

Copyright © 2021 Schneider Electric. All Rights Reserved.

Trademarks are owned by Schneider Electric Industries SAS or its affiliated companies. Other trademarks are owned by their respective companies.

Exclusion for Documentation

UNLESS SPECIFICALLY AGREED TO IN WRITING, SELLER

(A) MAKES NO WARRANTY AS TO THE ACCURACY, SUFFICIENCY OR SUITABILITY OF ANY TECHNICAL OR OTHER INFORMATION PROVIDED IN ITS MANUALS OR OTHER DOCUMENTATION;

(B) ASSUMES NO RESPONSIBILITY OR LIABILITY FOR LOSSES, DAMAGES, COSTS OR EXPENSES, WHETHER SPECIAL, DIRECT, INDIRECT, CONSEQUENTIAL OR INCIDENTAL, WHICH MIGHT ARISE OUT OF THE USE OF SUCH INFORMATION. THE USE OF ANY SUCH INFORMATION WILL BE ENTIRELY AT THE USER'S RISK; AND

(C) REMINDS YOU THAT IF THIS MANUAL IS IN ANY LANGUAGE OTHER THAN ENGLISH, ALTHOUGH STEPS HAVE BEEN TAKEN TO MAINTAIN THE ACCURACY OF THE TRANSLATION, THE ACCURACY CANNOT BE GUARANTEED. APPROVED CONTENT IS CONTAINED WITH THE ENGLISH LANGUAGE VERSION WHICH IS POSTED AT <https://solar.schneider-electric.com>.

Document Number: 990-91373A

Date: April 2021

Contact Information

For country-specific details, please contact your local Schneider Electric Sales Representative or visit the Schneider Electric Solar Business website at: <https://solar.schneider-electric.com>

READ AND SAVE THESE INSTRUCTIONS

Safety Information

Important Information

Read these instructions carefully and look at the equipment to become familiar with the device before trying to install, operate, service or maintain it. The following special messages may appear throughout this documentation or on the equipment to warn of potential hazards or to call attention to information that clarifies or simplifies a procedure.

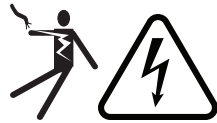

The addition of either symbol to a “Danger” or “Warning” safety label indicates that an electrical hazard exists which will result in personal injury if the instructions are not followed.



This is the safety alert symbol. It is used to alert you to potential personal injury hazards. Obey all safety messages that follow this symbol to avoid possible injury or death.

DANGER

DANGER indicates a hazardous situation which, if not avoided, **will result in** death or serious injury.

WARNING

WARNING indicates a hazardous situation which, if not avoided, **could result in** death or serious injury.

CAUTION

CAUTION indicates a hazardous situation which, if not avoided, **could result in** minor or moderate injury.

NOTICE

NOTICE is used to address practices not related to physical injury.

Please Note

Electrical equipment should be installed, operated, serviced, and maintained only by qualified personnel. No responsibility is assumed by Schneider Electric for any consequences arising out of the use of this material.

A qualified person is one who has skills and knowledge related to the construction, installation, and operation of electrical equipment and has received safety training to recognize and avoid the hazards involved. For more information, see *Audience*.

Label Symbols

NOTE: The term "ground" is equivalent to "earth", and the use of these terms depends on local codes and standards. This document uses the term "ground" throughout.

The following symbols appear on labels on or in the inverter.



Hazardous voltage



Hot surface



5 mins

Stored energy hazard discharge time



Refer to the Installation or Operation instructions



Protective (grounding) conductor terminal



Direct current

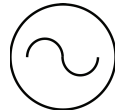

Alternating current

Audience

This guide is intended for any system integrators or engineers who plan to design an XW Pro Multi-Unit Power System using Schneider Electric equipment.

The qualified personnel have training, knowledge, and experience in:

- Installing electrical equipment.
- Applying all applicable installation codes.
- Analyzing and reducing the hazards involved in performing electrical work.
- Installing and configuring batteries.
- Selecting and using Personal Protective Equipment (PPE).

No responsibility is assumed by Schneider Electric for any consequences arising out of the use of this material.

About

Purpose

This Design Guide provides general information on designing a XW Pro Multi-Unit Power System using XW Pro inverterchargers in combination with other power devices like the Conext CL, Conext Gateway, Conext MPPT solar charge controller and Balance of System (BOS) components.

Scope

The Design Guide outlines design considerations and contains supportive information on design concepts. It does not contain specific instructions on how to build a Multi-Unit Power System. However, in "*Configurations Supported By Multi-Unit XW Pro System*" on page 24, the commissioning steps for each major configuration serve as definitive guidelines to follow when employing such configurations.

The information provided in this guide does not modify, replace, or waive any instruction or recommendations described in the product installation and owner's guides including warranties of Schneider Electric products. Always consult the installation and owner's guides of a Schneider Electric product when installing and using that product in an XW Pro Multi-Unit Power System.

For help in designing a power system contact your Schneider Electric Sales Representative or visit the Schneider Electric website for more information at <https://solar.schneider-electric.com>.

This Guide is focused on the performance and design of Multi-Unit Power Systems. It is expected that the reader has prior knowledge of performances and features of other Schneider Electric products which are installed and integrated into the system. All of this information are found in the following documents:

- XW Pro Owner's Guide (document number 990-91227 or 990-91402)
- XW Pro Installation Guide (document number 990-91228 or 990-91403)
- MPPT Charge/Controller Owner's Guide: 975-0400-01-01 and 975-0560-01-01
- Conext Gateway Owner's Guide (975-0806-01-01)
- AGS Owner's Guide: 975-0307-01-01
- Battery Monitor Owner's Guide: 975-0691-01-01
- AC Coupling Solutions Guide (document part number: 990-6421)
- XW Pro Li-Ion Battery Solution Guide (document number 990-6359)

Product Safety Information

IMPORTANT: Remember to read and follow all product safety information in this document.

General Safety Instructions

Before using the inverter/charger, read all instructions and cautionary markings on the unit, the batteries, and all appropriate sections of this manual.

- Use of accessories not recommended or sold by the manufacturer may result in a risk of fire, electric shock, or injury to persons.
- The inverter/charger is designed to be permanently connected to your AC and DC electrical systems. The manufacturer recommends that all wiring be done by a certified technician or electrician to ensure adherence to the local and national electrical codes applicable in your jurisdiction.
- To avoid a risk of fire and electric shock, make sure that existing wiring is in good condition and that wire is not undersized. Do not operate the inverter/charger with damaged or substandard wiring.
- Do not operate the inverter/charger if it has been damaged in any way.
- Most of the parts in this unit are not user-serviceable parts. Do not disassemble the inverter/charger except where noted for connecting wiring and cabling. Attempting to service the unit yourself may result in a risk of electrical shock or fire. Internal capacitors remain charged after all power is disconnected.
- To reduce the risk of electrical shock, disconnect both AC and DC power from the inverter/charger before attempting any maintenance or cleaning or working on any components connected to the inverter/charger. Putting the unit in Standby mode will not reduce this risk.
- The inverter/charger must be provided with an equipment-grounding conductor connected to the AC input ground.
- Do not expose this unit to rain, snow, or liquids of any type. This product is designed for indoor use only. Damp environments will significantly shorten the life of this product and corrosion caused by dampness will not be covered by the product warranty.
- To reduce the chance of short-circuits, always use insulated tools when installing or working with this equipment.
- Remove personal metal items such as rings, bracelets, necklaces, and watches when working with electrical equipment.
- Do not expose this unit to excessive shock or vibration. This product is designed for stationary indoor use only. Mechanical fatigue caused by excessive shock or vibration can significantly shorten the life of this product and will not be covered by the product warranty.

 **DANGER****HAZARD OF ELECTRIC SHOCK, EXPLOSION, ARC FLASH, AND FIRE**

This document is in addition to, and incorporates by reference, the relevant product manuals for XW Pro inverter/charger. Before reviewing this document, you must read the relevant product manuals. Unless specified, information on safety, specifications, installation and operation is as shown in the primary documentation received with the product. Ensure you are familiar with that information before proceeding.

Failure to follow these instructions will result in death or serious injury.

 **DANGER****HAZARD OF ELECTRIC SHOCK, EXPLOSION, ARC FLASH, AND FIRE**

- Apply appropriate personal protective equipment (PPE) and follow safe electrical work practices.
- This equipment must only be installed and serviced by qualified electrical personnel.
- Never operate energized with covers removed.
- Energized from multiple sources. Before removing covers identify all sources, de-energize, lock-out, and tag-out and wait 5 minutes for circuits to discharge
- Always use a properly rated voltage sensing device to confirm all circuits are de-energized.

Failure to follow these instructions will result in death or serious injury.

 **DANGER****HAZARD OF ELECTRIC SHOCK, EXPLOSION, ARC FLASH, AND FIRE**

- Disconnect negative and positive DC conductors before servicing. DC conductors are to be treated as Hazardous Live and must be disconnected.
- Normally GROUNDED conductors may be UNGROUNDED and ENERGIZED when a GROUND FAULT is indicated on the front panel. Must be serviced by qualified personnel.

Failure to follow these instructions will result in death or serious injury.

Precautions when Working with Batteries

NOTE: Battery work and maintenance must be done by qualified personnel knowledgeable about batteries to help ensure compliance with battery handling and maintenance safety precautions.

DANGER

HAZARD OF ELECTRIC SHOCK, EXPLOSION, OR ARC FLASH

- Remove watches, rings, or other metal objects.
- This equipment must only be installed and serviced by qualified electrical personnel.
- Keep sparks and flames away from the batteries.
- Use tools with insulated handles.
- Wear protective glasses, gloves and boots.
- Do not lay tools or other metal parts on top of batteries.

Failure to follow these instructions will result in death or serious injury.

DANGER

HAZARD OF ELECTRICAL SHOCK, EXPLOSION, OR FIRE

- Battery Circuit Breakers must be installed according to the specifications and requirements defined by Schneider Electric.
- Servicing of batteries must only be performed by qualified personnel knowledgeable about batteries and the required precautions. Keep unqualified personnel away from batteries.
- Disconnect the charging source prior to connecting or disconnecting battery terminals.

Failure to follow these instructions will result in death or serious injury.

Explosive Gas Precautions

Working in the vicinity of lead acid batteries is dangerous. Batteries generate explosive gases during normal operation. Therefore, you must read this Installation Guide and all other relevant product manuals and follow the instructions exactly.

To reduce the risk of battery explosion, follow these instructions and those published by the battery manufacturer and the manufacturer of the equipment in which the battery is installed.

NOTICE

STATEMENT OF HAZARD

Use only a soft cloth dampened with water and mild soap to clean the inverter.

Do not use solvents or chemicals that are corrosive or flammable.

Failure to follow these instructions can result in equipment damage.

Contents

Safety Information	3
Label Symbols	4
Audience	5
About	6
Purpose	6
Scope	6
Product Safety Information	7
General Safety Instructions	7
Precautions when Working with Batteries	9
Explosive Gas Precautions	9
Introduction	13
Conext Multi-Unit Power System	14
Applications of a Multi-Unit Power System	14
Types of XW Pro Multi-Unit Power Systems	15
Multi-Unit Inverter System Structure	16
Xanbus®	16
Master / Slave	17
XW Pro Multi-unit Power System	19
Electrical Architecture	20
Limitations of the XW Pro	20
Configurations Supported By Multi-Unit XW Pro System	24
Single/Split-Phase without External Contactor	26
Electrical Configuration and Power Ratings (Single/Split-Phase without External Contactor)	26
Commissioning (Single/Split-Phase without External Contactor)	27
Single/Split-Phase with External Contactor	29
Electrical Configuration and Power Ratings (Single/Split-Phase with External Contactor)	29
Commissioning (Single/Split-Phase with External Contactor)	31
Single/Split-Phase with no AC Source	34
Electrical Configuration and Power Ratings (Single/Split-Phase with no AC Source)	34
Commissioning (Single/Split-Phase with no AC Source)	35
Three-phase without External Contactor	37
Electrical Configuration and Power Ratings (Three-phase without External Contactor)	37
Commissioning (Three-phase without External Contactor)	38
Three-phase with External Contactor	40

Electrical Configuration and Power Ratings (Three-phase with External Contactor) 40

Commissioning (Three-phase with External Contactor) 43

Three-phase with no AC Source 46

 Electrical Configuration and Power Ratings (Three-phase with no AC Source) 46

 Commissioning (Three-phase without AC Source) 47

Design of Multi-unit Power Systems 49

 How To Identify Multi-Unit Power System Project Needs 50

 Identify Functionalities Expected for the System 50

 Define the Load Profile of the System 50

 Define Surge Rating of the System. 52

 Know Maximum Ambient Temperature at which the System will Operate 53

 Difficulties Identifying a Suitable Solution for the Project 53

 Sizing a Generator for a Multi-Unit Power System 53

 AC-coupled System 53

 Features that are Not Available with External Contactor Configurations 53

 Components of a Modular XW Pro Multi-Unit Power System 55

AC Output Voltage Configuration and Calibration 59

 Audience 60

 Prerequisites 60

 Procedure 60

 Calibration without Load 60

 Calibration with Load (Power Sharing/Balancing) 64

1 Introduction

What's in This Chapter?

Conext Multi-Unit Power System	14
Applications of a Multi-Unit Power System	14
Types of XW Pro Multi-Unit Power Systems	15
Multi-Unit Inverter System Structure	16
Xanbus®	16
Master / Slave	17

Conext Multi-Unit Power System

A Multi-Unit Power System is a group of battery-based XW Pro inverter/chargers and related devices which are physically assembled together, electrically connected together, and configured to operate as a single power source.

The objective of the grouping is to create a power system capable of supplying more power than what can be provided by a single inverter.

Figure 1 Example of a Multi-Unit Power System

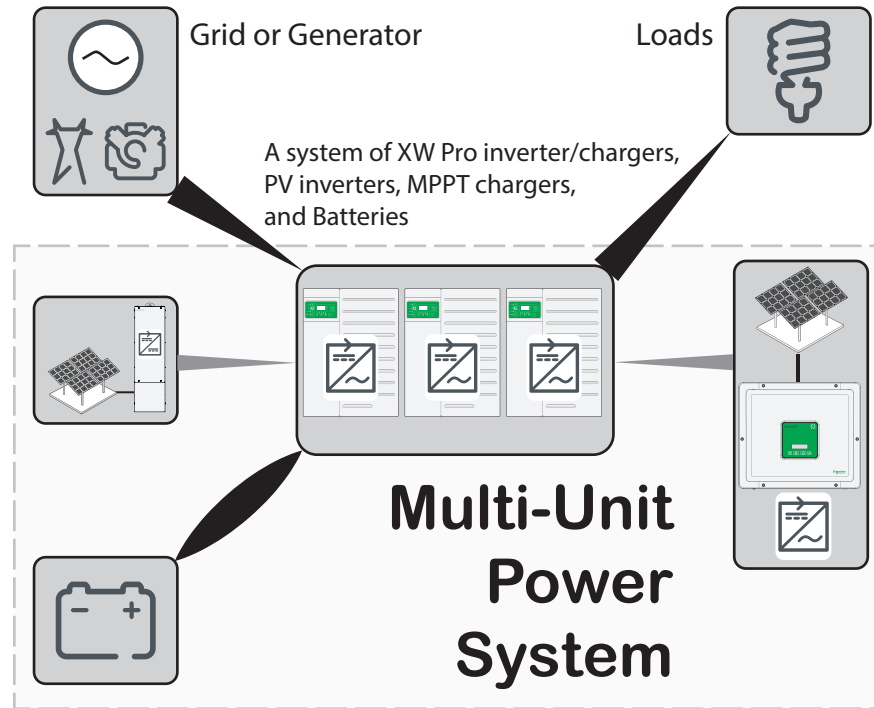

Multi-Unit Power System can be used as a grid-tie power backup equipment or as primary power sources for off-grid sites. They may or may not have solar energy harvest capability or other alternate energy sources.

Electrically, all the power devices are connected to a common AC and DC bus using appropriate circuit breakers, electrical panels, combiner boxes and/or power distribution panels (PDP).

A full function Multi-Unit Power System is able to harvest energy (store it, regulate it, and distribute it) through AC breaker panels. If the system is equipped with solar energy harvest capability, harvested energy that is not stored may be consumed on site, may be exported to the grid, or a combination of the two depending on the multi-unit configuration.

Multi-Unit Power Systems have different applications, many types and power ratings, and a structure that forms the system, as described in the following pages.

Applications of a Multi-Unit Power System

A Multi-Unit Power System can do one or more of the following:

- provide power to off-grid residences, businesses, and communities
- reduce fuel consumption by minimizing the run time of a generator
- export harvested solar energy to the grid
- harvest solar energy to reduce diesel consumption
- provide backup power on unreliable grids
- offset utility grid power consumption during times of peak power tariff
- monitor the power system including its batteries for performance, maintenance and troubleshooting purposes

NOTE: The features and functionality offered by Multi-Unit Power Systems vary depending on the configuration. For more information on these configurations, see *"Configurations Supported By Multi-Unit XW Pro System" on page 24*.

Types of XW Pro Multi-Unit Power Systems

Multi-Unit Single-Phase or Split-Phase Power System

A multiple inverter power system of XW Pro inverters can consist of two, three, or four battery-based inverters along with additional AC or DC-Coupled solar arrays. For information on AC Coupled Systems, refer to the AC Coupling Solutions Guide (document part number: 990-6421).

Three-Phase Power System

A three-phase system consists of three or six XW Pro inverters (grouped into sets of three) physically connected and configured so that collectively they produce three-phase power. The XW Pro inverters can only be configured in a WYE three-phase configuration; delta configuration is not supported.

NOTICE

RISK OF EQUIPMENT DAMAGE

Before being used in a three-phase system, XW Pro 6848 units must be converted from 240 V to 120 V. See XW Pro Installation Guide (document number 990-91228 or 990-91403) for more details.

Failure to follow these instructions can result in equipment damage.

Figure 2 Three-phase WYE connection (120/208 VAC for XW Pro 6848 or 230/400 VAC for XW Pro 8548)

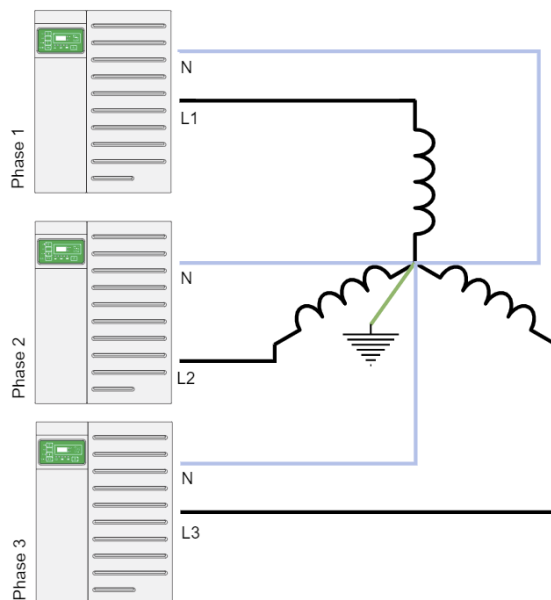

Multi-Unit Inverter System Structure

Xanbus®

To enable system communication and multi-unit operation, each XW Pro is equipped with a Xanbus network port (through which each XW Pro identify and communicate with each other) and an AC Sync port (through which the XW Pro units synchronize their AC outputs). Refer to *Xanbus Network Size* on page 24 for more information.

Figure 3 AC sync and Xanbus ports

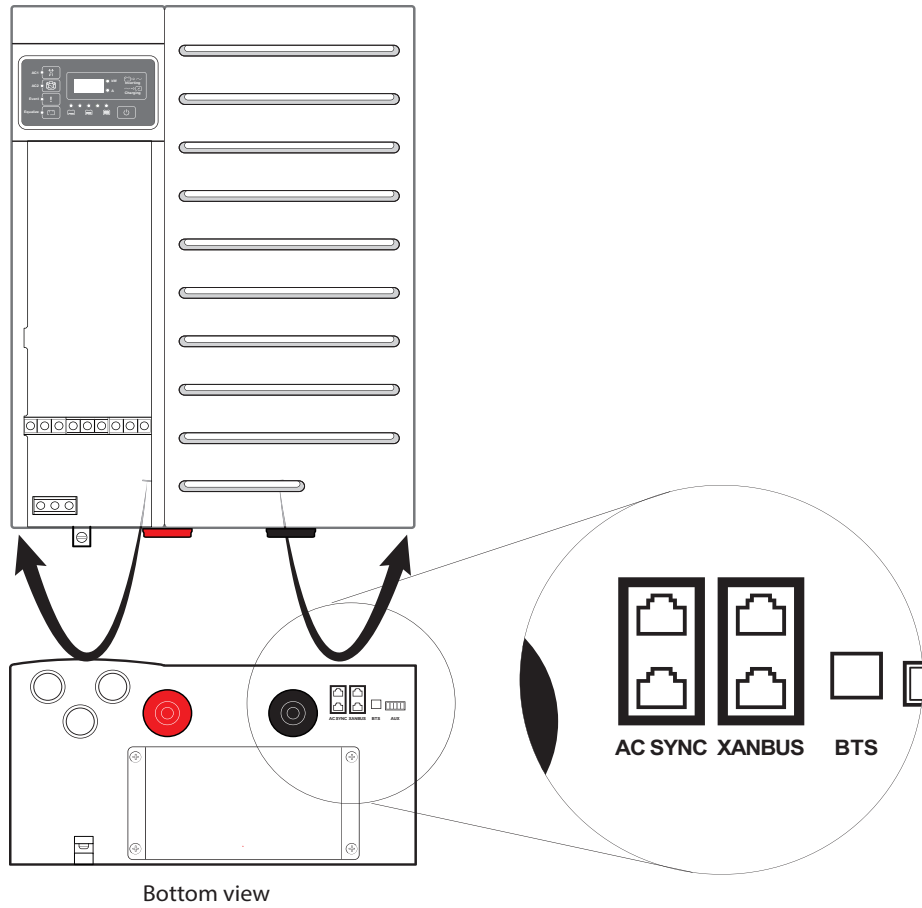

Master / Slave

XW Pro inverters use a Master/Slave device structure, where one inverter in split-/single-phase systems, or three inverters in 3-phase systems are designated as a Master unit and all other inverters (which are parallel-connected to a Master) are designated as Slave units.

2 XW Pro Multi-unit Power System

What's in This Chapter?

Electrical Architecture	20
Limitations of the XW Pro	20
Configurations Supported By Multi-Unit XW Pro System	24
Single/Split-Phase without External Contactor	26
Electrical Configuration and Power Ratings (Single/Split-Phase without External Contactor)	26
Commissioning (Single/Split-Phase without External Contactor)	27
Single/Split-Phase with External Contactor	29
Electrical Configuration and Power Ratings (Single/Split-Phase with External Contactor)	29
Commissioning (Single/Split-Phase with External Contactor)	31
Single/Split-Phase with no AC Source	34
Electrical Configuration and Power Ratings (Single/Split-Phase with no AC Source)	34
Commissioning (Single/Split-Phase with no AC Source)	35
Three-phase without External Contactor	37
Electrical Configuration and Power Ratings (Three-phase without External Contactor)	37
Commissioning (Three-phase without External Contactor)	38
Three-phase with External Contactor	40
Electrical Configuration and Power Ratings (Three-phase with External Contactor)	40
Commissioning (Three-phase with External Contactor)	43
Three-phase with no AC Source	46
Electrical Configuration and Power Ratings (Three-phase with no AC Source)	46
Commissioning (Three-phase without AC Source)	47

Electrical Architecture

Limitations of the XW Pro

Like any system, the XW Pro is subject to technical limitations. For anyone designing a system using XW Pro, it is important to have a clear understanding of what the XW Pro can and cannot do.

These limitations are:

- Output power rating limit of the system
- Hardware limitation: maximum current rating of the internal relay
- Product compatibility
- Xanbus network size

Output Power Rating

Table 1 XW Pro 8548 (IEC) ratings

XW Pro 8548 (230V Configuration)			
Continuous (kVA)		Peak (kVA) @25C (30-min)	Grid-Sell (kVA)
@25C	@40C		
6.8	6.0	8.5	6.0

Table 2 XW Pro 6848 (UL) ratings

XW Pro 6848 (120V/240V Configuration)			XW Pro 6848 (120V Configuration)				
Continuous (kVA)		Peak (kVA) @25C (30-min)	Grid-Sell (kVA)	Continuous (kVA)		Peak (kVA) @25C (30-min)	Grid-Sell (kVA)
@25C	@40C			@25C	@40C		
6.8	6.0	8.5	6.0	5.76	5.76	7.2	5.76

Power limitations of the XW Pro are specified in *Table 1* and *Table 2*. One very important thing to notice is that each power rating is specified for a period of time and a given ambient temperature. As a result, both ambient temperature and load profile should be considered when sizing the system.

When analyzing the 30-minute peak power rating, the load profile shown in *Figure 4 on page 21* should be considered. It means that, when subjected to an ambient temperature of 25 °C, each XW Pro (230 V or 120/240 V configuration) can handle 8.5 kVA of load for 30 minutes with 45-minute break in between. If the load profile is more aggressive than this, for example, the 8.5 kVA of load is applied for 30 minutes with 10-minute break in between., then the internal temperature of the XW Pro may rise above the limit and the XW Pro will trigger its overload protection warning first (**W63**), then overload fault detection (**F63**) in order to protect the unit from being damaged.

Also, it should be noted that these ratings are in Volt-Ampere (Apparent Power: **kVA**). This means that it corresponds to the RMS value of the voltage multiplied by the RMS value of the current. Power factor is not considered in this rating. If XW Pro units are used in an installation with a power factor lower than 1, then active power output

capability (in Watts) of the multi-unit system should be evaluated accordingly by multiplying the expected power factor by the rated Volt-Ampere rating of the XW Pro.

For residential applications, the power factor is usually very close to unity, therefore, Watt and Volt-Ampere ratings are very close. However, for large commercial applications where several inductive loads are installed, power factor is decreased to a lower value (typically 0.75 – 0.85).

Figure 4 30-minute Peak Power Rating of XW Pro 8548

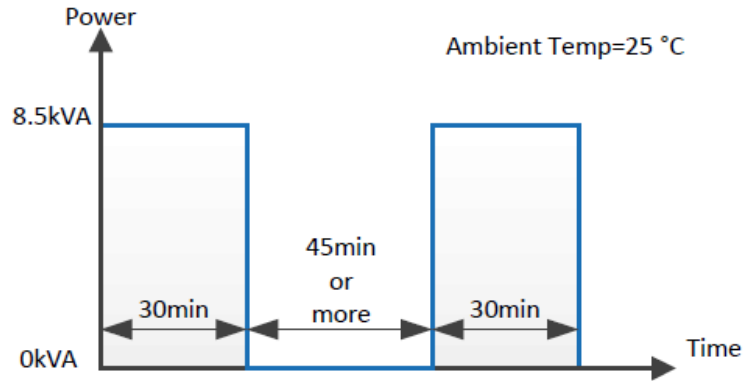

Hardware Limitation: Maximum Current Rating of the Internal Relay

The Internal electrical structure of the XW Pro is shown in Figure 5. Two electric relays, rated at 60 A each, are located at the inputs (**AC1** and **AC2**) of the XW Pro.

Figure 5 Electrical Architecture of XW Pro

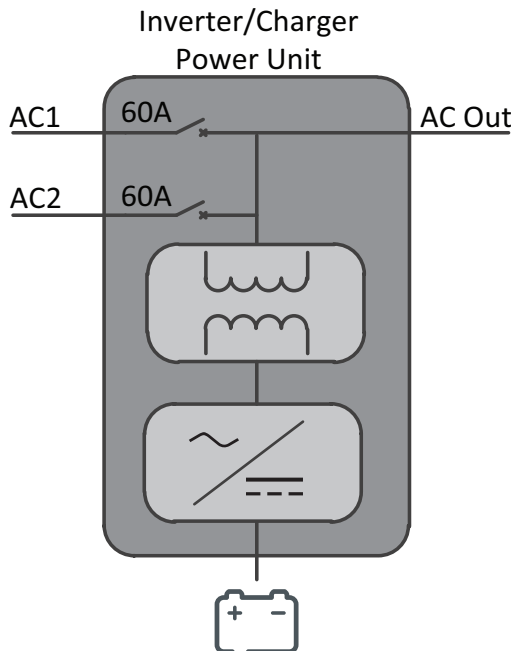

NOTE: AC1 and AC2 can refer to either grid or generator power.

Because of these 60 A rated relays, the current flowing through the **AC1** and **AC2** ports of the XW Pro is limited accordingly. When several units are placed in parallel and operating in AC pass-through mode, they will all be connected to the same AC source

and share a fairly even amount of current to the load. However, when the AC source is disqualified, it is not possible to ensure that every relay will open at the exact same time (see *Figure 7 on page 23*). The last relay to open will have to handle the total overall load current. In addition, when qualifying, the first relay to close will have to handle the total system current.

As a result, when using the internal transfer relays to switch the AC sources, a maximum of 60 A of loads can be connected to the AC Out port of the inverter. For systems with loads larger than 60 A, it is necessary to use an external contactor for switching the AC Source.

The use of an external contactor will be described and explained later in *"Configurations Supported By Multi-Unit XW Pro System" on page 24*.

Figure 6 Internal relay behavior with good AC

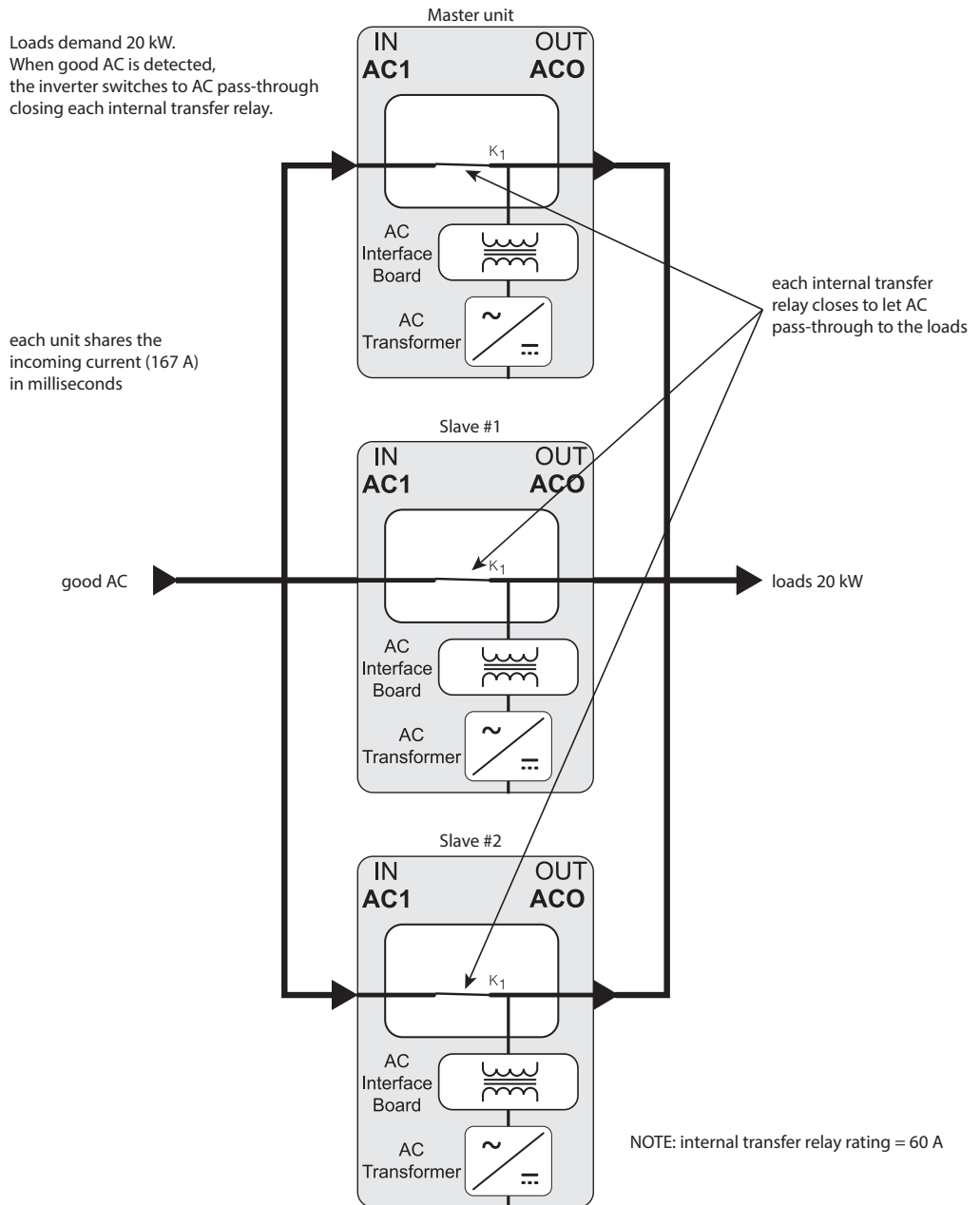
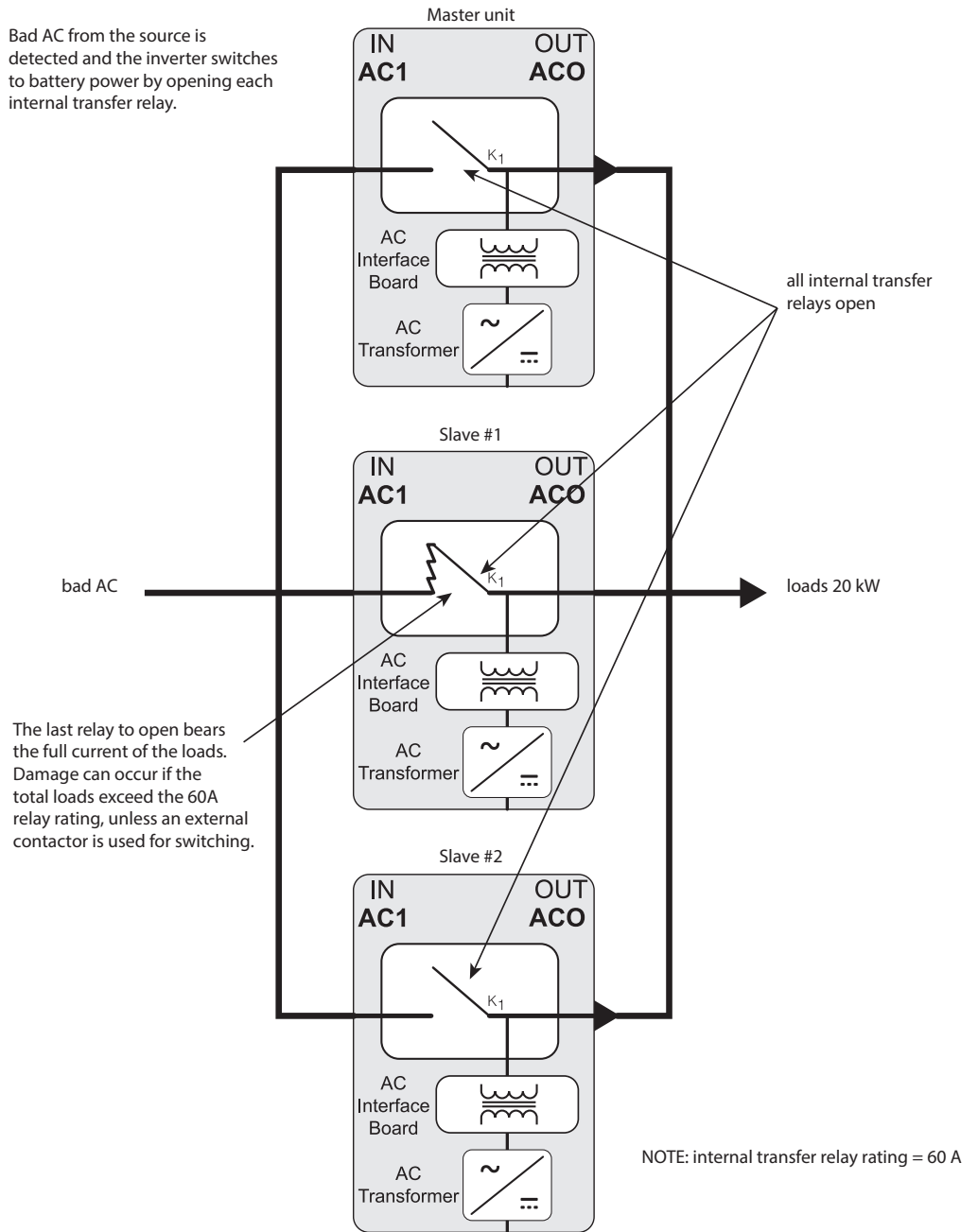

Figure 7 Internal relay behavior with bad AC



Product Compatibility

NOTICE
EQUIPMENT DAMAGE
Do not mix and match XW Pro models in a multi-unit configuration.
Failure to follow these instructions can result in equipment damage.

A Multi-Unit Power System requires all the units to be the same model and their firmware versions to be identical.

Xanbus Network Size

The Xanbus network which is based on CAN bus communication protocols interconnects the various Conext and/or Xanbus-enabled devices. The Xanbus network allows communication between the devices but has limited bandwidth in regards to the amount of data that can be exchanged through it.

Systems must be connected in a way that full capacity per Xanbus bus is not exceeded.

As a first choice customer must attempt to connect all devices on a single Xanbus, but if single Xanbus capacity is exceeded, the second Xanbus must be used. The same class of devices must be connected to the same Xanbus, for example XW Pro inverters must be on bus 1 and charge controllers on bus 2. When only one Xanbus is required, InsightHome or InsightFacility can be used. When two Xanbus buses are required, only InsightFacility can be used.

	InsightHome	InsightFacility
Xanbus Networks	1	2
Max. Qty. XW Pro	4 units single phase or split phase	4 units single phase or split phase
	6 units three phase	6 units three phase
Max. Total Connected XW Pro and MPPT Charge Controllers	6	18*
Examples	3 XW Pro + 3 MPPT + AGS	6 XW Pro + 12 MPPT + AGS + Battery Monitor
	2 XW Pro + 4 MPPT + AGS + Battery Monitor	4 XW Pro + 12 MPPT + AGS + Battery Monitor
	6 XW Pro	

* All XW Pro and optional AGS or Battery Monitor must be connected on the same Xanbus network. If the system includes more than six total XW Pro and MPPT charge controllers devices, then MPPT charge controllers must be connected on the other Xanbus network.

Configurations Supported By Multi-Unit XW Pro System

NOTICE
EQUIPMENT DAMAGE
Do not install a power system that is not based on any of the six configurations listed in this section.
Failure to follow these instructions can result in equipment damage.

Multi-Unit Power Systems are based on the modularity offered by the XW Pro platform. This modularity enables many configurations to be designed. However, they are all subject to the "Limitations of the XW Pro" on page 20. The following topics will introduce multi-unit XW Pro configurations supported by Schneider Electric and their associated performances. All of them are summarized in Table 3. In addition, depending on customer

needs, each configuration may include supplementary components. For example, a manual bypass switch is recommended to be added to connect the backup loads directly to the grid during maintenance or in case any issues with energy storage system.

Table 3 List of supported multi-unit configurations

Phase Configuration	AC Source	External Contactor	Unit/Cluster Quantity
<i>Single/Split-Phase without External Contactor</i>	Yes	No	2 units (230V or 120/240V only)
<i>Single/Split-Phase with External Contactor</i>	Yes	Yes	up to 4 units
<i>Single/Split-Phase with no AC Source</i>	No	No	up to 4 units
<i>Three-phase without External Contactor</i>	Yes	No	3 Units (120/208V)* 6 Units (230/400V)*
<i>Three-phase with External Contactor</i>	Yes	Yes	6 units
<i>Three-phase with no AC Source</i>	No	No	6 units

* Refer to configuration details for more information. Configurations with an AC source and no external contactor require that the aggregate connected backup loads are <60 A.

Single/Split-Phase without External Contactor

- Single/split-phase system
- Connected to an AC source
- Without external contactor

Electrical Configuration and Power Ratings (Single/Split-Phase without External Contactor)

As mentioned in the introduction, each XW Pro inverter has a built-in transfer relay rated at 60 A. This internal transfer relay lets an AC source, such as utility grid AC, pass-through to the loads. When the flow of AC source is interrupted, the transfer relays open and the inverters enter inverting mode to supply power to the loads from the battery. In configurations such as the one represented in *Figure 8* where no external transfer switch is being used, the backup loads on AC Out are limited to 60 A. As a result, associated power ratings and supported features are listed in *Table 4* and *Table 5*.

Figure 8 Single/split-phase – without external contactor configuration

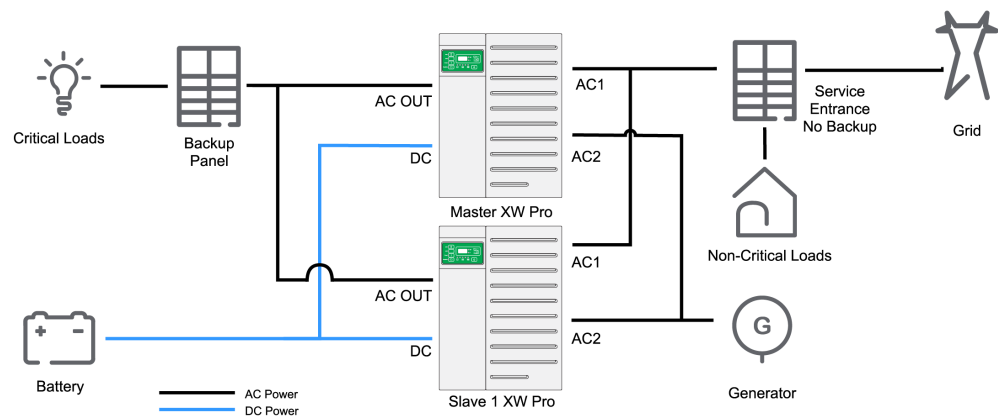

AC and DC-coupled sources are not represented for simplicity. However, they can be integrated into the system as shown in *Figure 9* on page 29.

Table 4 XW Pro multi-unit power system ratings for IEC – without external contactor

Unit	XW Pro 8548 (230V Configuration)			
	Continuous (kVA)		Peak (kVA) @25C (30-min)	Grid-Sell (kVA)
	@25C	@40C		
2-unit	13.6	12.0	13.8*	12.0

* Peak power is limited by the characteristics of the 60A internal relay.

Table 5 XW Pro multi-unit power system ratings for NA – without external contactor

Unit	XW Pro 6848 (120V/240V Configuration)*			
	Continuous (kVA)		Peak (kVA) @25°C (30-min)	Grid-Sell (kVA)
	@25°C	@40°C		
2-unit	13.6	12.0	14.4**	12.0

* XW Pro 6848 (120V Configuration): Multi-unit configuration without external contactor is not supported.

** Peak power is limited by the characteristics of the maximum 60A internal relay.

Features supported by this configuration

- All features supported by XW Pro in single unit configuration
- Grid Support
- Generator Support, peak power shaving, backup, sell
- DC coupled or AC coupled PV.

Commissioning (Single/Split-Phase without External Contactor)

 **DANGER**

HAZARD OF ELECTRIC SHOCK, EXPLOSION, ARC FLASH, AND FIRE

- Apply appropriate personal protective equipment (PPE) and follow safe electrical work practices. See .
- This equipment must only be installed and serviced by qualified electrical personnel.
- Never operate energized with covers removed
- Energized from multiple sources. Before removing covers identify all sources, de-energize, lock-out, and tag-out and wait 5 minutes for circuits to discharge
- Always use a properly rated voltage sensing device to confirm all circuits are de-energized.

Failure to follow these instructions will result in death or serious injury.

During installation of a single-phase system with AC source and no external contactor, the following steps should be followed:

1. Disconnect the system from any AC and DC sources (Grid and/or Generator and battery) and open all AC and DC breakers.
2. Verify that all the wiring has been properly done.
 - a. **AC1/AC2** connected to AC source
 - b. **AC Out** connected to the load panel
 - c. All units (XW Pro, Conext Gateway, Battery Monitor, MPPT Charge Controller, etc.) are connected through Xanbus in a daisy chain configuration

with terminators

- d. All Sync Cables are connected between the XW Pro units without terminators
3. Verify that all the breakers are open at the output of the XW Pro (**AC Out**).
4. Close the DC breaker/s (that is, the battery) to power up the system.
5. Verify that the firmware version installed on each Schneider Electric product (XW Pro, Conext Gateway, MPPT, AGS, etc) corresponds to the latest released version (available on <http://solar.schneider-electric.com>). If not, download latest firmware from the website and update each unit accordingly.
6. Assign proper battery association to match wiring of the system.
7. Configure XW Pro settings according to desired operating mode (see the XW Pro Owner's Guide).
8. Verify that the output voltage of each XW Pro unit is within ± 0.5 VAC range (measured at the AC Load terminal of each inverter, with the XW Pro grid forming and AC source disconnected). To do the verification, you will have to temporarily put the units in **Operating** mode, with AC source disconnected.
 - a. If the units are not within the range, recalibrate the unit/s following the instructions in "*AC Output Voltage Configuration and Calibration*" on page 59.
 - b. Return the units to **Standby** mode.
9. Configure one unit as split or single-phase Master and all the other ones as split or single-phase Slave units, with different device numbers.
10. Under a **No Load** condition, close every breaker at the output of the XW Pro.
11. Put the units in **Operating** mode.
12. Verify that the system is generating a stable AC output voltage.
13. Load the system and verify that all the units are supplying the correct phase power to the load.
14. Turn On the AC source.
15. Verify that the AC source voltage and frequency is within the specified range (the AC1 LED blinks on each inverter and then remains ON when the XW Pro qualifies the AC source).
16. Turn off the AC source and verify that the XW Pro units go into invert mode.
17. The system is now ready to be configured according to the application case (such as battery type, advanced features, and others).

Single/Split-Phase with External Contactor

- Single/split-phase system
- Connected to an AC source
- With external contactor

NOTE: The AC current rating of the load determines when the external contactor is required. It is typically required to install an external contactor with three or more XW Pro units for 120/240 V split phase or 230 V single phase systems. For 120 V single phase systems an external contactor is required for two or more XW Pro units.

Electrical Configuration and Power Ratings (Single/Split-Phase with External Contactor)

Figure 9 Single/split-phase – with external contactor configuration – only either AC or DC coupling is supported.

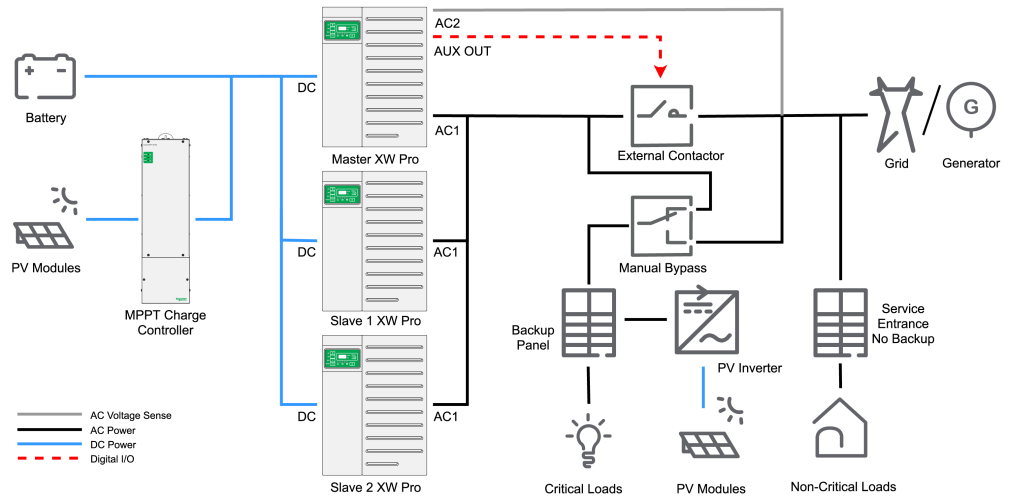

It is recommended to installed a manual bypass switch to connect backup loads to the grid in case of maintenance procedures or issues with the energy storage system. An appropriately-rated SquareD or Schneider Electric ComPact INS/INV series double throw switch can be used.

Figure 10 External contactor AUX port and mains connection diagram (split-phase 120V/240V configuration shown)

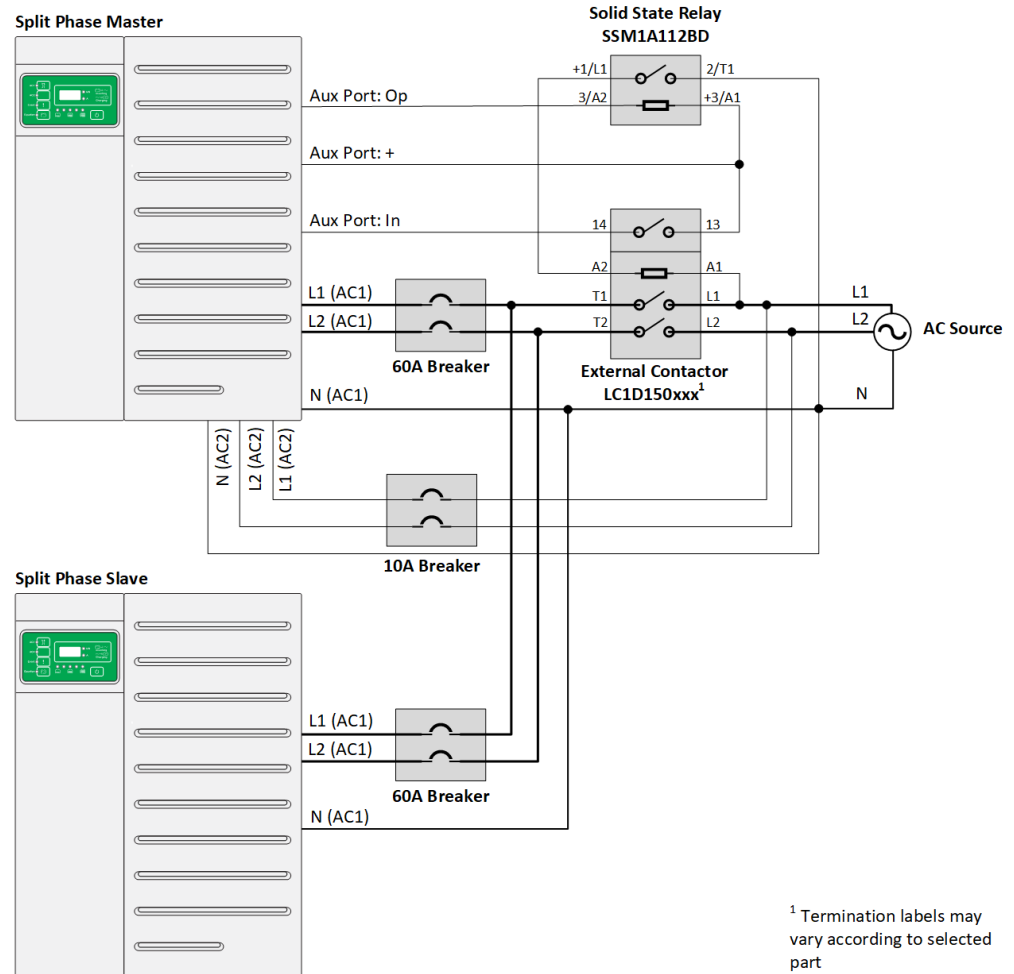

When more power is needed than a single XW Pro can provide, multiple units can be connected in parallel to create a multi-unit system with an increased power rating.

If the AC current rating of the load is higher than 60 A and the multi-unit system needs to be connected to an AC source, then an external contactor is required to collectively connect the system to the AC source instead of relying on the asynchronous nature of the 60 A transfer relays internal to each XW Pro. For specific contactor part numbers see *Table 17 on page 55*. Power limitations of this configuration are specified in *Table 6* and *Table 7* below.

Table 6 XW Pro multi-unit power system ratings for IEC – with external contactor

Unit	XW Pro 8548 (230V Configuration)			
	Continuous (kVA)		Peak (kVA) @25C (30-min)	Grid-Sell (kVA)
	@25C	@40C		
2-unit	13.6	12.0	17.0	12.0
3-unit	20.4	18.0	25.5	18.0
4-unit	27.2	24.0	34.0	24.0

Table 7 XW Pro multi-unit power system ratings for NA – with external contactor

Unit	XW Pro 6848 (120V/240V Configuration)				XW Pro 6848 (120V Configuration)			
	Continuous (kVA)		Peak (kVA) @25°C (30-min)	Grid-Sell (kVA)	Continuous (kVA)		Peak (kVA) @25°C (30-min)	Grid-Sell (kVA)
	@25°C	@40°C			@25°C	@40°C		
2-unit	13.6	12.0	17.0	12.0	11.52*	11.52*	14.4**	11.52*
3-unit	20.4	18.0	25.5	18.0	17.28*	17.28*	21.6**	17.28*
4-unit	27.2	24.0	34.0	24.0	23.04*	23.04*	28.8**	23.04*

* Continuous and grid-sell power in single-and split-phase systems is limited by 80% breaker derating rule of NEC when using the maximum 60A breaker which is required with all XW Pro models.

** Peak power is limited by the trip characteristics of the maximum 60A breaker .

Features supported by this configuration

- Off-grid and grid-connected systems
- Backup
- Sell power back to grid
- DC coupled or AC coupled PV.

Refer to *Features that are Not Available with External Contactor Configurations* on page 53 for a list of XW Pro limitations for this application.

Commissioning (Single/Split-Phase with External Contactor)

 **DANGER**

HAZARD OF ELECTRIC SHOCK, EXPLOSION, ARC FLASH, AND FIRE

- Apply appropriate personal protective equipment (PPE) and follow safe electrical work practices. See .
- This equipment must only be installed and serviced by qualified electrical personnel.
- Never operate energized with covers removed
- Energized from multiple sources. Before removing covers identify all sources, de-energize, lock-out, and tag-out and wait 5 minutes for circuits to discharge
- Always use a properly rated voltage sensing device to confirm all circuits are de-energized.

Failure to follow these instructions will result in death or serious injury.

NOTICE

RISK OF DAMAGE TO THE GENERATOR OR BATTERY INVERTER

In a system with external contactor and generator acting as AC source (connected to AC1), Grid support, Sell and Load Shave functions must be disabled on master and slave XW Pro units. XW Pro inverters will not be able to regulate the power to match AC loads and may backfeed AC power into the generator. In addition, IEEE 1547 - 2003 grid code must be used for 60 Hz and IEC 61727-2004 grid code must be used for 50 Hz to avoid smart grid interactive functions interfering with generator.

Failure to follow these instructions can result in equipment damage.

During the installation of a single or split-phase system with external contactor, the following steps should be followed:

1. Disconnect the system from any AC and DC sources (Grid and/or Generator and battery) and open all AC and DC breakers.
2. Verify that all the wiring has been properly done.
 - a. **AC1** connected to the external contactor
 - b. **AC2** connected to the AC source side of the external contactor to detect the status of the AC source voltage
 - c. **AC Out** unterminated (not connected to anything)
 - d. **AUX port** of the Master unit connected to a solid state relay (SSR) as shown in *Figure 10 on page 30*
 - e. External contactor connected to the load panel
 - f. All units (XW Pro, Battery Monitor, MPPT Charge Controller, Gateway, etc.) are connected through Xanbus in a daisy chain configuration with terminators
 - g. All Sync Cables are connected between the XW Pro units without terminators
3. Verify all AC breakers at the output of the XW Pro (**AC1**) are open.
4. Close the DC breaker/s (that is, the battery) to power up the system.
5. Verify that the firmware version installed on each Schneider Electric product (XW Pro, MPPT, AGS, Conext Gateway, etc) corresponds to the latest released version (available on <http://solar.schneider-electric.com>). If not, download latest firmware from the website and update each unit accordingly.
6. Assign proper battery association to match wiring of the system.
7. Configure XW Pro settings according to the desired operating mode (see the XW Pro Owner's Guide).
8. If a generator is used as an AC source, the user must do the following additional steps on master and slave XW Pro inverters:
 - a. Disable Grid Support, Sell and Load Shave
 - b. Select IEEE 1547-2003 grid code for 60 Hz and IEC 61727-2004 grid code for 50 Hz

9. Verify that the output voltage of each XW Pro unit is within ± 0.5 VAC range (measured at the AC Load terminal of each inverter, with the XW Pro grid forming and AC source disconnected). To do the verification, you will have to temporarily put the units in **Operating** mode, with AC source disconnected.
 - a. If the units are not within the range, recalibrate the unit/s following the instructions in "*AC Output Voltage Configuration and Calibration*" on page 59.
 - b. Return the units to **Standby** mode.
10. Configure one unit as single or split-phase Master and all the other ones as single or split-phase Slave units, with different device numbers.
11. Under a **No Load** condition, close every breaker at the output of the XW Pro.
12. Enable the External Transfer Contactor¹ of all units using the Conext Gateway web application.
13. Put the units in **Operating** mode.
14. Verify that the system is generating a stable AC output voltage.
15. Load the system and verify that all the units are supplying the correct phase power to the load.
16. Turn on the AC source.
17. Verify that the AC source voltage and frequency is within specified range, and the AC1 LED is blinking on the Master unit.
18. Verify that after the LED starts blinking, the Master unit's **AUX port** generates a 12 V output which will close the external contactor and connect the XW Pro units to the AC source.
19. Verify that once the Master units have qualified the AC source, then the Slave units do the same and the AC1 LED goes solid green.

¹This feature controls the external contactor according to the status of the power source's AC voltage, detected on AC2. When this feature is Enabled the following occurs:

- When voltage source is qualified at AC2 port, then the AUX port provides 12V across JU-1 and JU-4.
- When there is no voltage source qualified at AC2 port, then the AUX port acts as open circuit across JU-1 and JU-4.

Single/Split-Phase with no AC Source

- Single/split-phase system
- No AC source
- Without external contactor

Electrical Configuration and Power Ratings (Single/Split-Phase with no AC Source)

Figure 11 Single/split-phase – without external contactor or AC source configuration

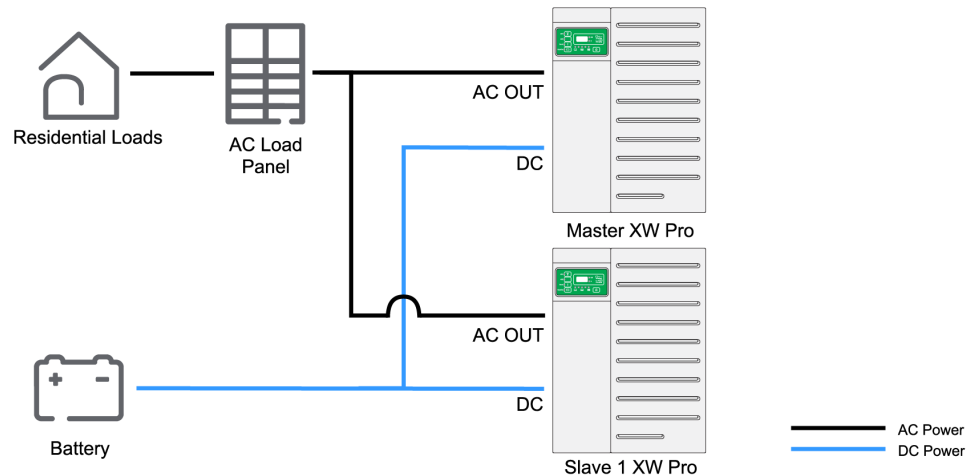

Although they are required in this configuration, AC and DC-coupled sources are not represented for simplicity. However, they can be integrated into the system as shown in *Figure 9 on page 29*.

In the configuration shown in *Figure 11*, the system is not connected to any AC source. As a result, no current will ever be circulating through the internal relays of the XW Pro and no external contactor is required above 60 A loads in this configuration. The maximum number of units and power ratings are listed in *Table 8* and *Table 9*:

Table 8 XW Pro multi-unit power system ratings for IEC – without external contactor or AC source

Unit	XW Pro 8548 (230V Configuration)			
	Continuous (kVA)		Peak (kVA) @25C (30-min)	Grid-Sell (kVA)
	@25C	@40C		
2-unit	13.6	12.0	17.0	N/A
3-unit	20.4	18.0	25.5	N/A
4-unit	27.2	24.0	34.0	N/A

Table 9 XW Pro multi-unit power system ratings for NA – without external contactor or AC source

Unit	XW Pro 6848 (120V/240V Configuration)				XW Pro 6848 (120V Configuration)			
	Continuous (kVA)		Peak (kVA) @25°C (30-min)	Grid-Sell (kVA)	Continuous (kVA)		Peak (kVA) @25°C (30-min)	Grid-Sell (kVA)
	@25°C	@40°C			@25°C	@40°C		
2-unit	13.6	12.0	17.0	N/A	11.52*	11.52*	14.4**	N/A
3-unit	20.4	18.0	25.5	N/A	17.28*	17.28*	21.6**	N/A
4-unit	27.2	24.0	34.0	N/A	23.04*	23.04*	28.8**	N/A

* Continuous and grid-sell power in single- and split-phase systems is limited by 80% breaker derating rule of NEC when using the maximum 60A breaker which is required with all XW Pro models.

** Peak power is limited by the trip characteristics of the maximum 60A breaker .

Features supported by this configuration

- Off-grid system only, with no AC source
- All features supported by XW Pro in single unit configuration
- DC coupled or AC coupled PV.

Commissioning (Single/Split-Phase with no AC Source)

DANGER

HAZARD OF ELECTRIC SHOCK, EXPLOSION, ARC FLASH, AND FIRE

- Apply appropriate personal protective equipment (PPE) and follow safe electrical work practices. See .
- This equipment must only be installed and serviced by qualified electrical personnel.
- Never operate energized with covers removed
- Energized from multiple sources. Before removing covers identify all sources, de-energize, lock-out, and tag-out and wait 5 minutes for circuits to discharge
- Always use a properly rated voltage sensing device to confirm all circuits are de-energized.

Failure to follow these instructions will result in death or serious injury.

During installation of a single-phase system not connected to an AC source, the following steps should be followed:

1. Disconnect the system from any AC and DC sources (Grid and/or Generator and battery) and open all AC and DC breakers.

2. Verify that all the wiring has been properly done.
 - a. **AC Out** connected to load panel with NO connections to AC1 or AC2
 - b. All units (XW Pro, Conext Gateway Battery Monitor, MPPT Charge Controller, etc.) are connected through Xanbus in a daisy chain configuration with terminators
 - c. All Sync Cables are connected between the XW Pro units without terminators
3. Verify that all breakers at the output of the XW Pro (**AC Out**) are open.
4. Close the DC breaker/s (that is, the battery) to power up the system.
5. Verify that the firmware version installed on each Schneider Electric product (XW Pro, Conext Gateway, MPPT, AGS, etc) corresponds to the latest released version (available on <http://solar.schneider-electric.com>). If not, download latest firmware from the website and update each unit accordingly.
6. Assign proper battery association to match wiring of the system.
7. Configure XW Pro settings according to desired operating mode (see the XW Pro Owner's Guide).
8. Verify that the output voltage of each XW Pro unit is within ± 0.5 VAC range (measured at the AC Load terminal of each inverter, with the XW Pro grid forming and AC source disconnected). To do the verification, you will have to temporarily put the units in **Operating** mode, with AC source disconnected.
 - a. If the units are not within the range, recalibrate the unit/s following the instructions in "*AC Output Voltage Configuration and Calibration*" on page 59.
 - b. Return the units to **Standby** mode.
9. Configure one unit as split or single-phase Master and all the other ones as split or single-phase Slave units, with different device numbers.
10. Under a **No Load** condition, close every breaker at the output of the XW Pro.
11. Put the units in **Operating** mode.
12. Verify that the system is generating a stable AC output voltage (UL-120/240 V / IEC-230 V).
13. The system is now ready to be configured according to the application case (such as battery type, advanced features, and others).
14. Load the system and verify that all the units are supplying the correct phase power to the load.
15. Turn On the AC source.
16. Verify that the AC source voltage and frequency is within the specified range (the AC1 LED blinks on each inverter and then remains ON when the XW Pro qualifies the AC source).

Three-phase without External Contactor

- Three-phase system
- Connected to an AC source
- Without external contactor

Electrical Configuration and Power Ratings (Three-phase without External Contactor)

Figure 12 Three-phase – without external contactor configuration

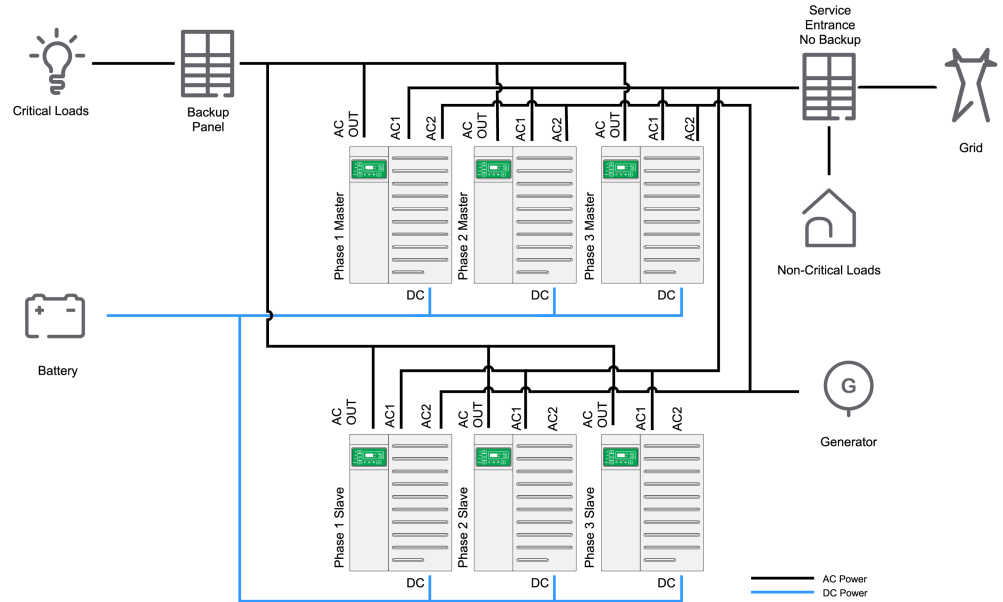

The XW Pro can be used for 3-phase systems by installing clusters of three inverters, with one inverter per phase. In configurations similar to the one displayed in *Figure 12* where no external contactor is being used, the system is subject to the 60 A limit of the internal relay. As a result, associated power ratings and the supported feature are listed in *Table 10* and *Table 11*.

Note that the XW Pro 8548 model can support up to two 3-phase clusters (6 units) in this configuration due to the synchronization limits of the inverters as well as the 60 A maximum loads. The XW Pro 6848 model (120 V) can typically support only one three-phase cluster (three units) in this configuration due to the 60 A maximum loads.

Table 10 XW Pro three-phase power system ratings for IEC - without external contactor

Unit	XW Pro 8548 (230V Configuration)			
	Continuous (kVA)		Peak (kVA) @25C (30-min)	Grid-Sell (kVA)
	@25C	@40C		
3-unit	20.4	18.0	25.5	18.0
6-unit	40.8	36.0	41.4*	36.0

* Peak power is limited by the characteristics of the 3-phase 60A internal relay.

Table 11 XW Pro three-phase power system ratings for NA - without external contactor

Unit	XW Pro 6848 (120V Configuration)			
	Continuous (kVA)		Peak (kVA) @25°C (30-min)	Grid-Sell (kVA)
	@25°C	@40°C		
3-unit	17.28*	17.28*	21.6**	17.28*

* Continuous and grid-sell power in three-phase systems is limited by 80% breaker derating rule of NEC when using the maximum 60A breaker which is required with all XW Pro models.

** Peak power is limited by the trip characteristics of the 3-phase maximum 60A breaker.

Features supported by this configuration

- Off-grid and grid-connected systems
- All features supported by XW Pro in single unit configuration
- DC coupled or AC coupled PV.

Commissioning (Three-phase without External Contactor)

 **DANGER**

HAZARD OF ELECTRIC SHOCK, EXPLOSION, ARC FLASH, AND FIRE

- Apply appropriate personal protective equipment (PPE) and follow safe electrical work practices. See .
- This equipment must only be installed and serviced by qualified electrical personnel.
- Never operate energized with covers removed
- Energized from multiple sources. Before removing covers identify all sources, de-energize, lock-out, and tag-out and wait 5 minutes for circuits to discharge
- Always use a properly rated voltage sensing device to confirm all circuits are de-energized.

Failure to follow these instructions will result in death or serious injury.

During installation of a three-phase system with an AC source and without an external contactor, the following steps should be followed:

1. Verify that no AC and DC source is connected to the units(Grid and/or Generator and battery) and open all AC and DC breakers.
2. Verify that all the wiring has been properly done.
 - a. **AC Out** connected to load panel
 - b. **AC1/AC2** connected to the AC source. Note which unit is connected to which phase of the AC source
 - c. All units (XW Pro,Conext Gateway, Battery Monitor, MPPT Charge Controller, etc.) are connected through Xanbus in a daisy chain configuration

with terminators

- d. All Sync Cables are connected between the XW Pro units without terminators
3. Verify that all breakers at the output of the XW Pro (**AC Out**) are open.
4. Close the DC breaker/s (that is, the battery) to power up the system.
5. Verify that all the units are in **Standby** mode.
6. Verify that the firmware version installed on each Schneider Electric product (XW Pro, Conext Gateway, MPPT, AGS, etc) corresponds to the latest released version (available on <http://solar.schneider-electric.com>). If not, download the latest firmware from the website and update each unit accordingly.
7. Assign proper battery association to match wiring of the system.
8. Configure XW Pro settings according to the desired operating mode (see the XW Pro Owner's Guide).
9. Verify that the output voltage of each XW Pro unit is within ± 0.5 VAC range (measured at the AC Load terminal of each inverter, with the XW Pro grid forming and AC source disconnected). To do the verification, you will have to temporarily put the units in **Operating** mode, with AC source disconnected.
 - a. If the units are not within the range, recalibrate the unit/s following the instructions in "*AC Output Voltage Configuration and Calibration*" on page 59.
 - b. Return the units to **Standby** mode.
10. Configure one cluster of three inverters (phase L1, L2, L3) as Master and the second set of three as slaves (each XW Pro must be assigned to the respective phase). Assign each a different device number.
11. Under a **No Load** condition, close every breaker at the output of the XW Pro.
12. Put the units in **Operating** mode.
13. Verify that the system is generating a stable AC output voltage.
14. Load the system and verify that all the units are supplying the correct phase power to the load.
15. Turn On the AC source.
16. Verify that the AC source voltage and frequency is within the specified range (the AC1 LED blinks on each inverter and then remains ON when the XW Pro qualifies the AC source).

Three-phase with External Contactor

- Three-phase system
- Connected to an AC source
- With external contactor

NOTE: The AC current rating of the load determines when the external contactor is required. It is typically required to install an external contactor with six XW Pro units for 120/208V three-phase systems. For 230/400V three-phase systems, an external contactor is optional based on customer preference or when 30-min load rating exceeds 60 A.

Electrical Configuration and Power Ratings (Three-phase with External Contactor)

Figure 13 Three-phase – with external contactor configuration

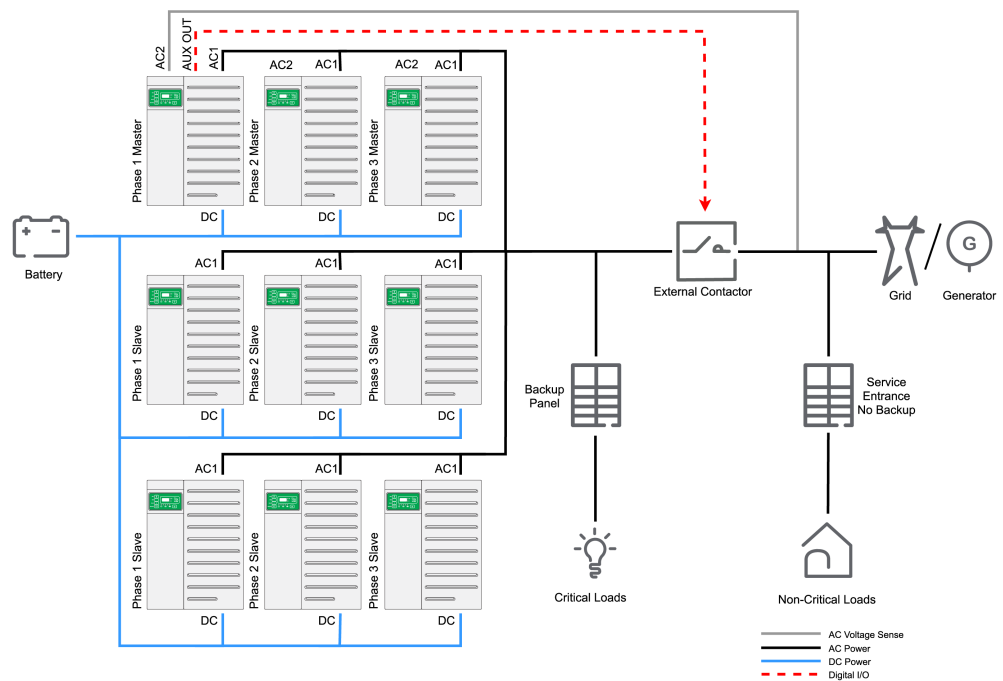

It is recommended to installed a manual bypass switch to connect backup loads to the grid in case of maintenance procedures or issues with the energy storage system. An appropriately-rated SquareD or Schneider Electric ComPact INS/INV series double throw switch can be used.

Figure 14 External contactor AUX port and mains connection diagram (three-phase 230/400V configuration shown)

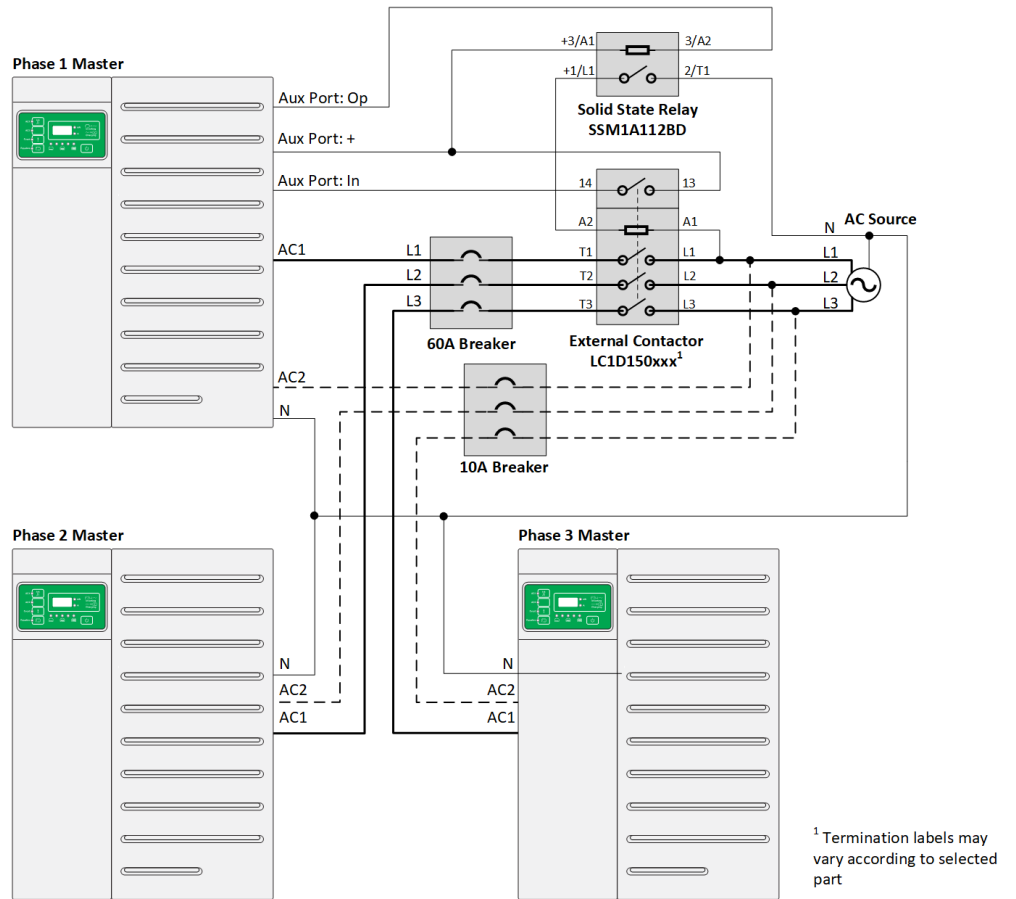
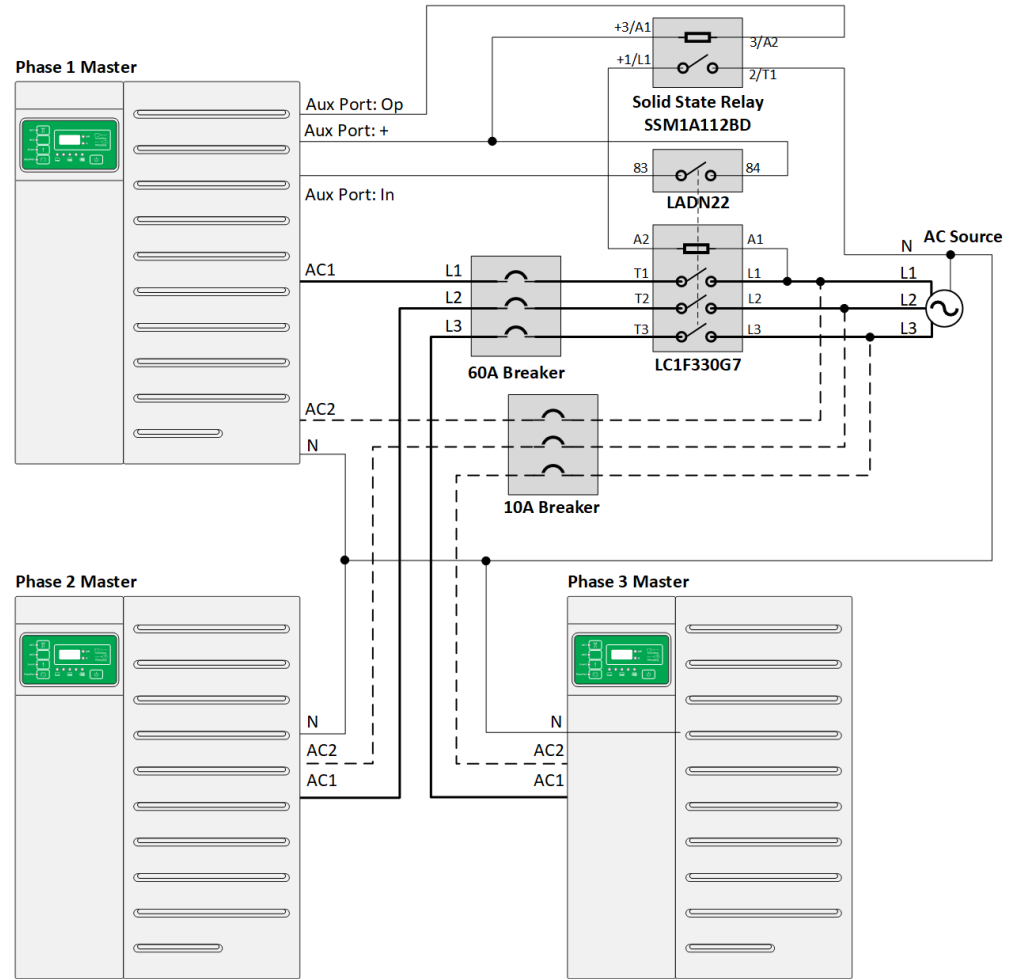

Figure 15 External contactor AUX port and mains connection diagram (three-phase 120/208V configuration shown)



For larger three phase systems, up to two 3-phase clusters (6 XW Pro units) can be connected in parallel, limited by the synchronization limits of the inverters.

If the AC current rating of the load is higher than 60 A and the multi-unit system needs to be connected to an AC source, then an external contactor is required to collectively connect the system to the AC source instead of relying on the asynchronous nature of the 60 A transfer relays internal to each XW Pro. For specific contactor part numbers see *Table 17 on page 55*.

Power ratings of the three-phase XW Pro power system with external AC contactor are listed in *Table 12* and *Table 13*.

Table 12 XW Pro three-phase power system ratings for IEC - with external contactor

Unit	XW Pro 8548 (230V Configuration)			
	Continuous (kVA)		Peak (kVA) @25C (30-min)	Grid-Sell (kVA)
	@25C	@40C		
3-unit	20.4	18.0	25.5	18.0
6-unit	40.8	36.0	51.0	36.0

Table 13 XW Pro three-phase power system ratings for NA - with external contactor

Unit	XW Pro 6848 (120V Configuration)			
	Continuous (kVA)		Peak (kVA) @25°C (30-min)	Grid-Sell (kVA)
	@25°C	@40°C		
3-unit	17.28*	17.28*	21.6**	17.28*
6-unit	34.56*	34.56*	43.2**	34.56*

* Continuous and grid-sell power in three-phase systems is limited by 80% breaker derating rule of NEC when using the maximum 60A breaker which is required with all XW Pro models.

** Peak power is limited by the trip characteristics of the 3-phase maximum 60A breaker.

Features² supported by this configuration

- Off-grid and grid-connected systems
- Backup
- Sell power back to grid
- DC coupled or AC coupled PV.

Commissioning (Three-phase with External Contactor)

 **DANGER**

HAZARD OF ELECTRIC SHOCK, EXPLOSION, ARC FLASH, AND FIRE

- Apply appropriate personal protective equipment (PPE) and follow safe electrical work practices. See .
- This equipment must only be installed and serviced by qualified electrical personnel.
- Never operate energized with covers removed
- Energized from multiple sources. Before removing covers identify all sources, de-energize, lock-out, and tag-out and wait 5 minutes for circuits to discharge
- Always use a properly rated voltage sensing device to confirm all circuits are de-energized.

Failure to follow these instructions will result in death or serious injury.

² See information for features that are Not Available in this configuration on page 53

NOTICE

RISK OF DAMAGE TO THE GENERATOR OR BATTERY INVERTER

In a system with external contactor and generator acting as AC source (connected to AC1), Grid support, Sell and Load Shave functions must be disabled on master and slave XW Pro units. XW Pro inverters will not be able to regulate the power to match AC loads and may backfeed AC power into the generator. In addition, IEEE 1547 - 2003 grid code must be used for 60 Hz and IEC 61727-2004 grid code must be used for 50 Hz to avoid smart grid interactive functions interfering with generator.

Failure to follow these instructions can result in equipment damage.

During installation of a three-phase power system with external contactor, the following steps should be followed:

1. Disconnect the system from any AC and DC sources (Grid and/or Generator and battery) and open all AC and DC breakers.
2. Verify that all the wiring has been properly done.
 - a. **AC1** connected to the external contactor
 - b. **AC2** connected to the AC source side of the external contactor to detect the status of the AC source voltage
 - c. **AC Out** unterminated
 - d. **AUX port** of the three-phase Master phase 1 unit connected to a solid state relay (SSR).
 - e. External contactor connected to the load panel
 - f. All units (XW Pro, Battery Monitor, MPPT Charge Controller, Gateway, etc.) are connected through Xanbus in a daisy chain configuration with terminators
 - g. All Sync Cables are connected between the XW Pro units without terminators
3. Verify all AC breakers at the output of the XW Pro (**AC1**) are open.
4. Close the DC breaker/s (that is, the battery) to power up the system.
5. Verify that the firmware version installed on each Schneider Electric product (XW Pro, MPPT, AGS, Conext Gateway, etc) corresponds to the latest released version (available on <http://solar.schneider-electric.com>). If not, download latest firmware from the website and update each unit accordingly.
6. Assign proper battery association to match wiring of the system.
7. Configure XW Pro settings according to the desired operating mode (see the XW Pro Owner's Guide).
8. If a generator is used as an AC source, the user must do the following additional steps on master and slave XW Pro inverters:
 - a. Disable Grid Support, Sell and Load Shave
 - b. Select IEEE 1547-2003 grid code for 60 Hz and IEC 61727-2004 grid code for 50 Hz

9. Verify that the output voltage of each XW Pro unit is within ± 0.5 VAC range (measured at the AC Load terminal of each inverter, with the XW Pro grid forming and AC source disconnected). To do the verification, you will have to temporarily put the units in **Operating** mode, with AC source disconnected.
 - a. If the units are not within the range, recalibrate the unit/s following the instructions in "*AC Output Voltage Configuration and Calibration*" on page 59.
 - b. Return the units to **Standby** mode.
10. Configure one cluster of three inverters (phase L1, L2, L3) as Master and the second set of three as slaves (each XW Pro must be associated with the respective phase). Assign each a different device number.
11. Under a **No Load** condition, close every breaker at the output of the XW Pro.
12. Enable the External Transfer Contactor³ of all units using the Conext Gateway web application.
13. Put the units in **Operating** mode.
14. Verify that the system is generating a stable AC output voltage.
15. Load the system and verify that all the units are supplying the correct phase power to the load.
16. Turn on the AC source.
17. Verify that the AC source voltage and frequency is within specified range, and the AC1 LED is blinking on the Master unit.
18. Verify that after the LED starts blinking, the Master unit's **AUX port** generates a 12 V output which will close the external contactor and connect the XW Pro units to the AC source.
19. Verify that once the Master units have qualified the AC source, then the Slave units do the same and the AC1 LED goes solid green.

³This feature controls the external contactor according to the status of the power source's AC voltage, detected on AC2. When this feature is Enabled the following occurs:

- When voltage source is qualified at AC2 port, then the AUX port provides 12V across JU-1 and JU-4.
- When there is no voltage source qualified at AC2 port, then the AUX port acts as open circuit across JU-1 and JU-4.

Three-phase with no AC Source

- Three-phase system
- No AC source
- Without external contactor

Electrical Configuration and Power Ratings (Three-phase with no AC Source)

Figure 16 Three-phase – without external contactor or AC source configuration

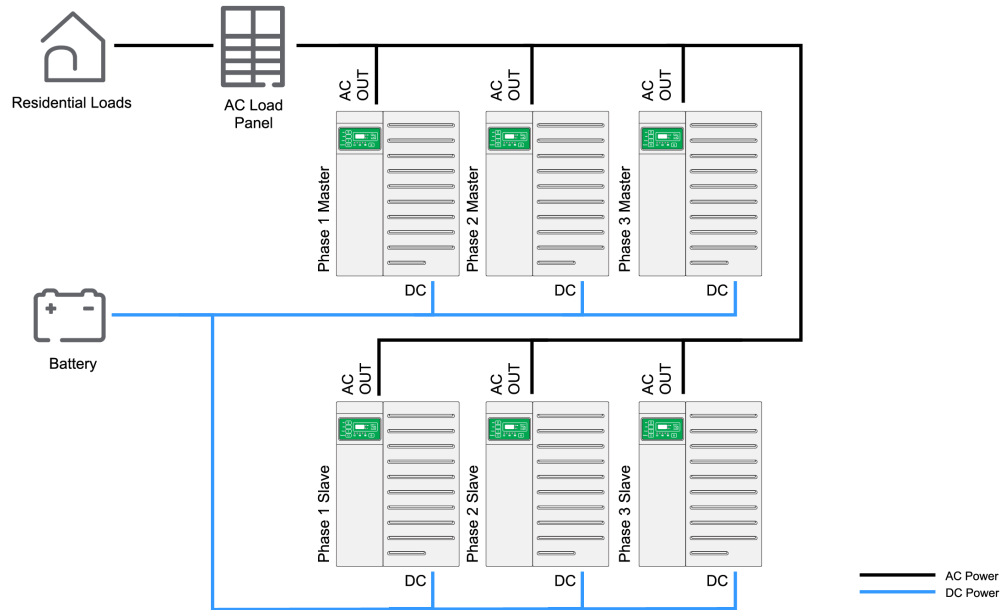

If no AC source is connected at the input of the XW Pro, then the internal relay current limitation is no longer in place for the system. As a result, associated power ratings and the supported feature by configuration in Figure 16 are listed in Table 14. The XW Pro 8548 and XW Pro 6848 models can support up to two three-phase clusters (6 units) in this configuration based on the synchronization limits of the inverter.

Table 14 XW Pro three-phase power system ratings for IEC - without external contactor or AC source

Unit	XW Pro 8548 (230V Configuration)			
	Continuous (kVA)		Peak (kVA) @25C (30-min)	Grid-Sell (kVA)
	@25C	@40C		
3-unit	20.4	18.0	25.5	18.0
6-unit	40.8	36.0	51.0	36.0

Table 15 XW Pro three-phase power system ratings for NA - without external contactor or AC source

Unit	XW Pro 6848 (120V Configuration)			
	Continuous (kVA)		Peak (kVA)	Grid-Sell (kVA)
	@25°C	@40°C	@25°C (30-min)	
3-unit	17.28*	17.28*	21.6**	17.28*
6-unit	34.56*	34.56*	43.2**	34.56*

* Continuous and grid-sell power in three-phase systems is limited by 80% breaker derating rule of NEC when using the maximum 60A breaker which is required with all XW Pro models.

** Peak power is limited by the trip characteristics of the 3-phase maximum 60A breaker.

Features supported by this configuration

- Off-grid systems, with no AC source
- All features supported by XW Pro in single unit configuration
- DC coupled or AC coupled PV.

Commissioning (Three-phase without AC Source)

 **DANGER**

HAZARD OF ELECTRIC SHOCK, EXPLOSION, ARC FLASH, AND FIRE

- Apply appropriate personal protective equipment (PPE) and follow safe electrical work practices. See .
- This equipment must only be installed and serviced by qualified electrical personnel.
- Never operate energized with covers removed
- Energized from multiple sources. Before removing covers identify all sources, de-energize, lock-out, and tag-out and wait 5 minutes for circuits to discharge
- Always use a properly rated voltage sensing device to confirm all circuits are de-energized.

Failure to follow these instructions will result in death or serious injury.

During installation of a three-phase system without a three-phase AC source, the following steps should be followed:

1. Verify that no AC and DC source is connected to the units(Grid and/or Generator and battery) and open all AC and DC breakers.

2. Verify that all the wiring has been properly done.
 - a. **AC Out** connected to load panel
 - b. All units (XW Pro, Conext Gateway, Battery Monitor, MPPT Charge Controller, etc.) are connected through Xanbus in a daisy chain configuration with terminators
 - c. All Sync Cables are connected between the XW Pro units without terminators
3. Verify that all breakers at the output of the XW Pro (**AC Out**) are open.
4. Close the DC breaker/s (that is, the battery) to power up the system.
5. Verify that all the units are in **Standby** mode.
6. Verify that the firmware version installed on each Schneider Electric product (XW Pro, Conext Gateway, MPPT, AGS, etc) corresponds to the latest released version (available on <http://solar.schneider-electric.com>). If not, download latest firmware from the website and update each unit accordingly.
7. Assign proper battery association to match wiring of the system.
8. Configure XW Pro setting accordingly to desired operating mode (see the XW Pro Owner's Guide).
9. Verify that the output voltage of each XW Pro unit is within ± 0.5 VAC range (measured at the AC Load terminal of each inverter, with the XW Pro grid forming and AC source disconnected). To do the verification, you will have to temporarily put the units in **Operating** mode, with AC source disconnected.
 - a. If the units are not within the range, recalibrate the unit/s following the instructions in "*AC Output Voltage Configuration and Calibration*" on page 59.
 - b. Return the units to **Standby** mode.
10. Configure one cluster of three inverters (phase L1, L2, L3) as Master and the second set of three as slaves (each XW Pro must be assigned to the respective phase). Assign each a different device number.
11. Under a **No Load** condition, close every breaker at the output of the XW Pro.
12. Put the units in **Operating** mode.
13. Verify that the system is generating a stable AC output voltage.
14. Load the system and verify that all the units are supplying the correct phase power to the load.
15. Turn On the AC source.
16. Verify that the AC source voltage and frequency is within the specified range (the AC1 LED blinks on each inverter and then remains ON when the XW Pro qualifies the AC source).

3 Design of Multi-unit Power Systems

What's in This Chapter?

How To Identify Multi-Unit Power System Project Needs	50
Identify Functionalities Expected for the System	50
Define the Load Profile of the System	50
Define Surge Rating of the System.	52
Know Maximum Ambient Temperature at which the System will Operate	53
Difficulties Identifying a Suitable Solution for the Project	53
Sizing a Generator for a Multi-Unit Power System	53
AC-coupled System	53
Features that are Not Available with External Contactor Configurations	53
Components of a Modular XW Pro Multi-Unit Power System	55

How To Identify Multi-Unit Power System Project Needs

As described previously, there are several electrical configurations which are possible for the Multi-Unit Power System and each of them offers different performances in terms of power rating and features.

This section will help you to understand how to select the proper system for your project.

Identify Functionalities Expected for the System

Verify which configuration can potentially meet your expectations in terms of features. For instance, it should be noted that architectures using an external contactor have some feature limitations such as schedule-based load shaving. Refer to *Features that are Not Available with External Contactor Configurations on page 53* for other limitations in this application.

Define the Load Profile of the System

The main functionality of the system is to provide electrical power to an installation. In order to size the system properly, it is necessary to know the load or loads to be powered. Before designing the system, it is recommended to monitor the installation using a power meter when possible. Information to be logged is:

- load profile (VA or Watt)
 - power factor if monitored load is in Watt
- If only the total load in Watt is available, Volt-Ampere (VA) power can be determined by dividing the Watt power by the power factor:
- $$P_{va} = P_{watt} / \text{PowerFactor}$$

Once the load profile in VA is defined, you need to define the following parameters:

- What is the peak load of the system?
- What is the highest load that is running for more than 30-minute?
- What is the average load?
- What is the continuous load?

Once you have determined these parameters, you can then compare them to the power rating tables given in the document and define a suitable configuration.

Example:

Figure 17 Load profile graph

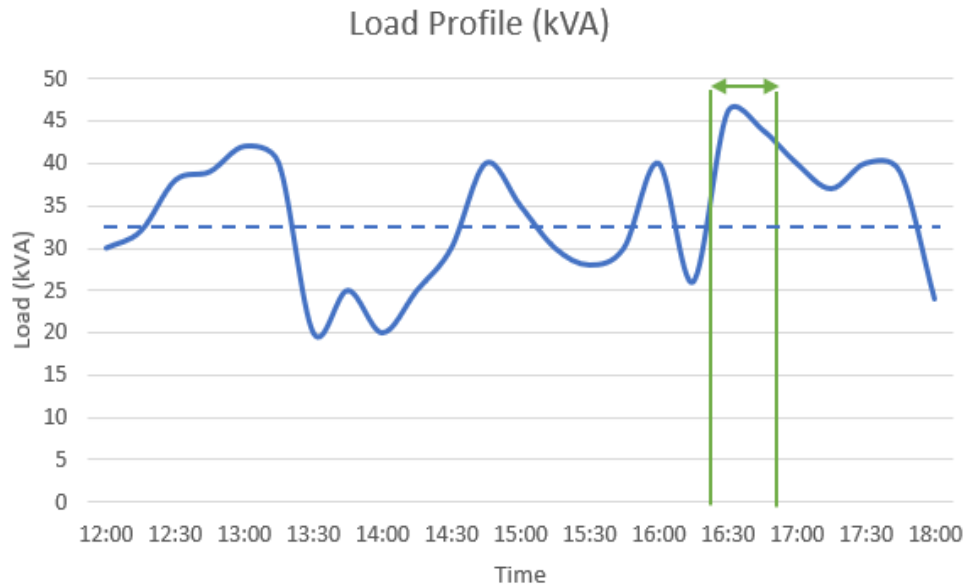

	Measured Load	Theoretical Rating
		6 XW Pro 8548 units
Avg. Power (kVA)	33	40.8 (continuous @ 25 °C)
Peak Power 30-minute (kVA)	47 kW for < 30 min	51 (@ 25 °C)

A load profile monitored in a commercial building is shown in *Figure 17*. It can be seen that this load profile is fairly uneven and presents many large load steps of several dozens of VA. In this case, it is difficult to identify a clear pattern for the load profile. Hence, in order to proceed to the design, it is required to identify what is the worst loading sequence for the system. A method of validating a design is to benchmark actual capabilities of the system with the measured load profile. In the given example here, we can see that the six-unit XW Pro system is able to supply the average power demand. In addition, the peak loads fall within the 30 min rating of the 6 XW Pro system, making it a suitable solution for this load profile.

Sometimes, it is not possible to get the measured load profile from the site. In this case, it is recommended to list the loads manually and add their power ratings together to estimate the peak power of the installation.

Figure 18 AC Overload Capability

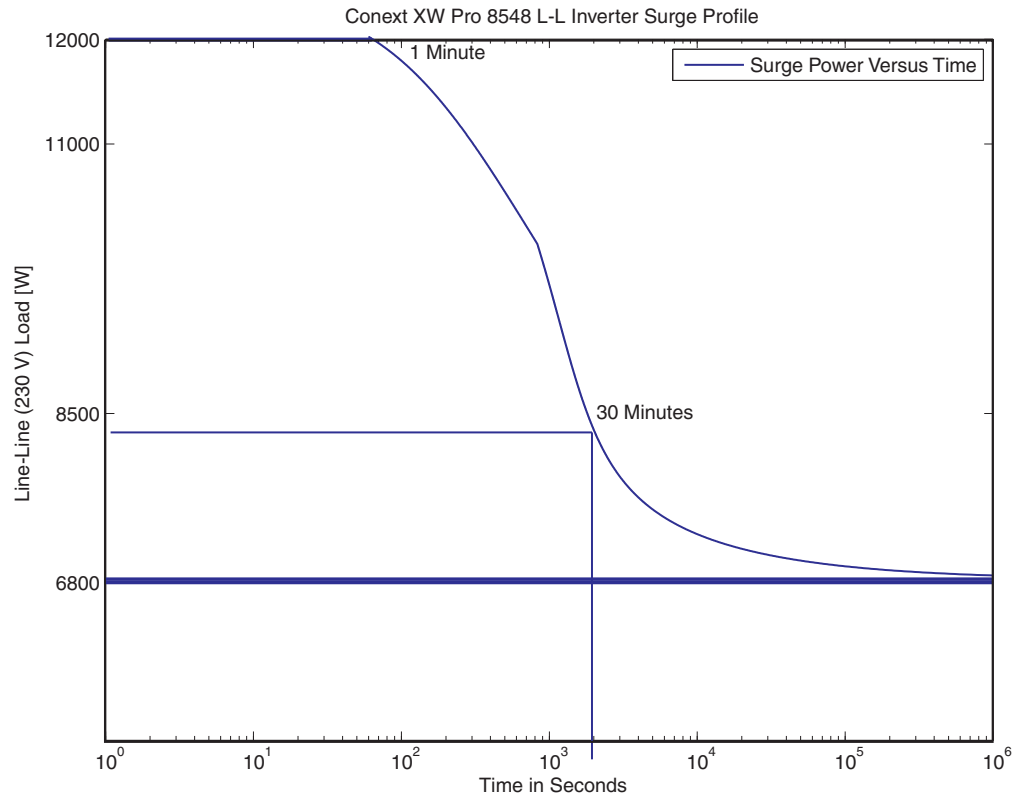

Define Surge Rating of the System.

If the installation includes a large electrical machine, it is likely that the system will be subjected to large inrush currents. Verify the LRA (Locked Rotor Ampere) values of the electrical machines to be started. The maximum inrush current of each load shall not be more than the maximum ratings specified in *Table 16*, and this is regardless of the number of XW Pro units comprising the cluster. If installation is subjected to this type of load, then it is recommended to install a **soft start** or **VFD** (variable frequency drives) system at the input of the electrical machine. This will reduce the inrush current and associated stress on the XW Pro units. You may contact your Schneider Electric SAE to receive information and support regarding soft starts and VFD devices.

The table below shows the maximum recommended motor load ratings without installing a means of reducing inrush current.

Table 16 Single Load Maximum Ratings

	Single-phase motor		Three-phase motor (per phase)		Inrush current per load
	kVA	HP	kVA	HP	
Maximum supported rating for XW Pro 8548 and 6848 models	2.4	3.2	4.0	5.6	53

NOTICE

EQUIPMENT DAMAGE

Follow the recommendations above to avoid the accelerated aging and subsequent failure of the components.

Failure to follow these instructions can result in equipment damage.

Know Maximum Ambient Temperature at which the System will Operate

Power rating is temperature dependent. As a result, it is important to define the ambient temperature in order to offer a proper design of the system. If the temperature is too high and the power demand is too high then you can consider installing an additional air cooling (such as, fan or air conditioner) system into the room.

Difficulties Identifying a Suitable Solution for the Project

It is possible that project requirements will overpass capabilities of offered solutions. In this case, it is often possible to work within (and around) the installation and make it compliant with the power rating of the XW Pro Multi-Unit Power System. Some of those solutions have already been mentioned in the previous points (for example, extra cooling system, VFD).

In addition to these, you can also explore the following three options:

- Split the loads into multiple smaller systems instead of one large system.
- Define a non-critical load panel that will be disconnected from the system during backup mode
- Install a load management system that will shut down some predefined loads when operating without an AC Source

Sizing a Generator for a Multi-Unit Power System

When selecting a generator, you should consider the total power demand that potentially will be applied at the AC output of the generator. This total power includes the load of the installation and the total charging power required by the battery bank(s). Considering this total power ensures that the system will be capable of supplying both the battery bank(s) charging current and supplying the load at the same time. If required, the maximum charging current per XW Pro unit can be configured through the Conext Config Tool (or Conext Gateway) and can be reduced to meet system requirements.

AC-coupled System

All configurations in this document can be AC coupled with grid tie PV inverters. Installers must design and install the system according to the AC Coupling Solutions Guide (document part number: 990-6421). In particular, take note of the PV inverter sizing limitations and the requirements for generator backfeed protection from AC coupled PV inverters.

Features that are Not Available with External Contactor Configurations

The following XW Pro features are not available.

- **Grid Support** for PV self-supply with grid sell limiting is not available, unless the PV is DC coupled and a compatible external power meter is added at the point of interconnection. Refer to the XW Pro Self-Supply and Grid Sell Limiting Solution Guide (document part number: 990-91371) for more information.
Note: The XW Pro can export energy to AC loads and the grid without the external meter, but requires the external meter to limit export to the grid.
- **Load Shave**
- **Search Mode**
- **Generator Support** for supplementing power to loads in excess of the generator rating
- **Conext Response** compatibility for DRED DRM0

The following AGS features are not available.

- **Inverter Load Start/Stop**- this AGS setting enables and disables the Load Start and Load Stop triggers. This mode of operation is not supported on systems with an external contactor. To prevent the generator from nuisance cycling when the XW Pro units are installed with an external contactor (that is, the generator starts and stops in a loop) set **Load = Disabled** under the **AGS Trigger Configuration** menu. Any other features involving state-of-charge (SoC) or battery voltage as a trigger source are supported by AGS.
- **Generator Cool Down Time** under **AGS Generator Configuration** menu
- External contactor configurations can only be connected to a single AC source (Generator or Grid).



The following Conext Gateway/ Insight features are not available.





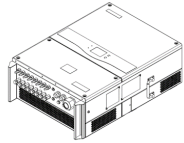
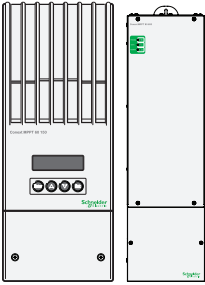

- Grid input power or energy metering and reporting
- Grid export power or energy metering and reporting
- Generator input power or energy metering and reporting
- Load output power or energy metering and reporting

Components of a Modular XW Pro Multi-Unit Power System

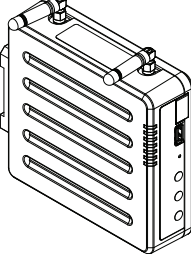
These are Schneider Electric power devices which can be used as components of the Conext XW Pro Multi-Unit Power System.

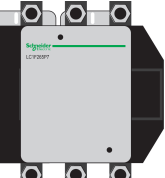
Table 17 Components of a modular XW Pro multi-unit power system

Building Blocks	Description	Product Number
Power Conversion Devices		
 <p>XW Pro Inverter/Charger North America (NA) and IEC</p>	<p>XW Pro 8548 (230 V) website</p>	<p>865-8548-61</p>
	<p>XW Pro 6848 (120/240 V) website</p>	<p>865-6848-21</p>
 <p>CL 30, CL 33, CL 50 3-phase Inverter</p>  <p>CL36E 3-phase Inverter</p>	<p>CL 30 website</p>	<p>PVSCL30E</p>
	<p>CL 33 website</p>	<p>PVSCL33E</p>
	<p>CL 36E website</p>	<p>PVSCL36E</p>
	<p>CL 50 website</p>	<p>PVSCL50E</p>
 <p>MPPT Solar Charge Controllers</p>	<p>Conext MPPT 60 150 website</p>	<p>865-1030-1</p>
	<p>Conext MPPT 80 600 website</p>	<p>865-1032</p>
	<p>Conext MPPT 100 600 website</p>	<p>865-1034</p>
Monitoring and Communication Devices		

Building Blocks	Description	Product Number
 <p>Conext Battery Monitor</p>	<p>Conext Battery Monitor website</p>	<p>865-1080-01</p>
 <p>Conext Gateway</p>	<p>Conext Gateway website</p>	<p>865-0329</p>
 <p>Conext AGS</p>	<p>Conext AGS website</p>	<p>865-1060-01</p>
Balance of Systems (BOS)		
 <p>External Contactor</p>	<p>TeSys Contactor</p>	<p>Single (120V and 230V) and three-phase (230/400V) systems: LC1D150G7 (120V coil) - clamp terminals LC1D1506G7 (120V coil) - lug terminals LC1D150P7 (230V coil) - clamp terminals LC1D1506P7 (230V coil) - lug terminals Three-phase (120/208V) systems: LC1F330G7</p>
 <p>Auxiliary Contactor</p>	<p>TeSys K Auxiliary Contactor</p>	<p>LADN22 Note: Only required for three-phase (120/208V) systems where external contactor part number LC1F330G7</p>
 <p>Solid State Relay</p>	<p>Solid State Relay (SSR)</p>	<p>SSM1A112BD</p>
 <p>PDP</p>	<p>Conext Power Distribution Panel (PDP) website</p>	<p>865-1015-01</p>
Commissioning and Configuration Device		

Building Blocks	Description	Product Number
Conext Config Tool	Configuration device and program website	865-1155-01

NOTE: The above listing of devices does not include all the components which can be a part of a Multi-Unit Power System. The system designer is responsible for compliance with local codes and standards and application requirements. Contact your Schneider Electric SAE for further support or guidance.

A AC Output Voltage Configuration and Calibration

What's in This Chapter?

Audience	60
Prerequisites	60
Procedure	60
Calibration without Load	60
Calibration with Load (Power Sharing/Balancing)	64

Audience

This procedure is intended for qualified installers of the XW Pro.

Prerequisites

- Applicable only to multi-unit XW Pro power systems.
- USB-CAN adapter
- Config Tool AI software (Visit <https://solar.schneider-electric.com/product/conext-configuration-tool/> or contact your Sales Representative at solar.schneider-electric.com/contact-us).
- Professional calibrated voltmeter

Procedure

Calibration without Load

Important: This calibration procedure must be performed without loads and with battery power only. Disengage from grid power, if the XW Pro units are grid connected.

1. Install the Conext Configuration Tool drivers and Configuration Tool AI software according to instructions included in the software package in a Windows-based PC (Windows 10 operating systems).
NOTE: For Win XP, be sure it has been updated to SP2 or SP3.
2. Disable the **Search** mode on all inverters.
3. Verify that all AC output breakers are opened (switched off).
4. Measure the **L1-to-L2** voltage (for 120/240 V systems) or the **L** voltage (for 230 V systems) at the **AC LOAD** terminals of each inverter using a voltmeter.
Observe that the measurements are likely off by more than ± 0.6 V between each unit. If the units are measuring exactly the same, double check that they are not accidentally still paralleled.
5. Turn Off all the XW Pro inverter/chargers AC and DC breakers to start the calibration process.
6. Turn On only the XW Pro inverter/charger that needs to be calibrated.
Important: If the XW Pro is a Master unit, then proceed to the next step. If it is a Slave unit, then configure it to Master first before proceeding to the next step. To change the **Inverter Mode** go to: **Advanced Settings** -> **Multi-Unit Config** -> **Inverter Mode**
7. Open the Configuration Tool AI by launching the application in your PC.
The Configuration Tool AI main screen appears.

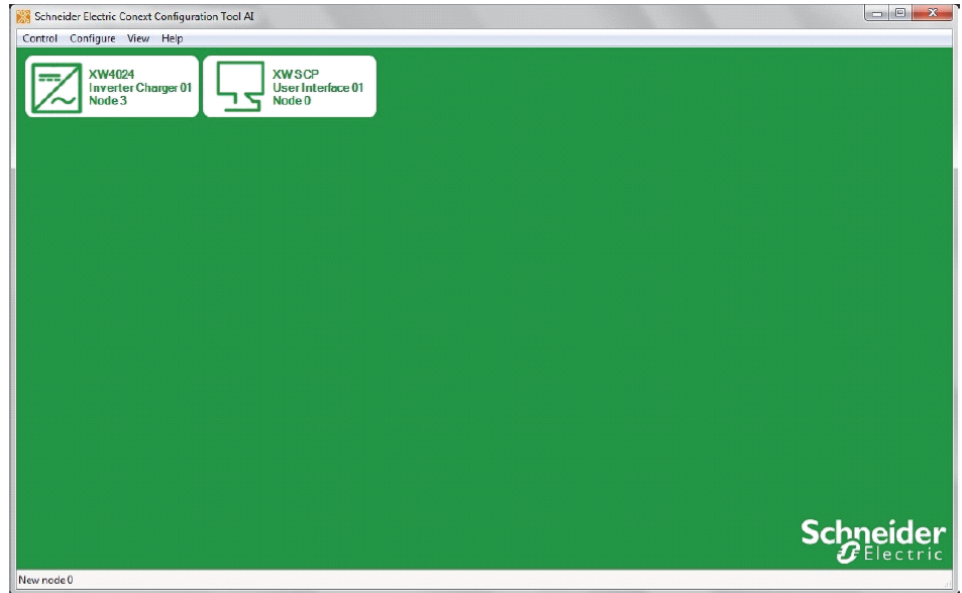

NOTE: Only the XW Pro unit to be calibrated (in step 6) should appear here. If other XW Pro units are appearing, then these units must be turned off via the AC and DC breakers. Repeat step 5 for these units. Other Xanbus devices need not be turned off.

8. From the Configuration Tool AI main screen, assign the unit to be calibrated as a **Master**.
On 120/240 V units, Master is **SplitPhaseMaster**. On 230 V units, Master is **StandAloneMaster**.
9. Click the XW Pro Multi-Unit Power System device icon.
The XW Pro Device screen appears.

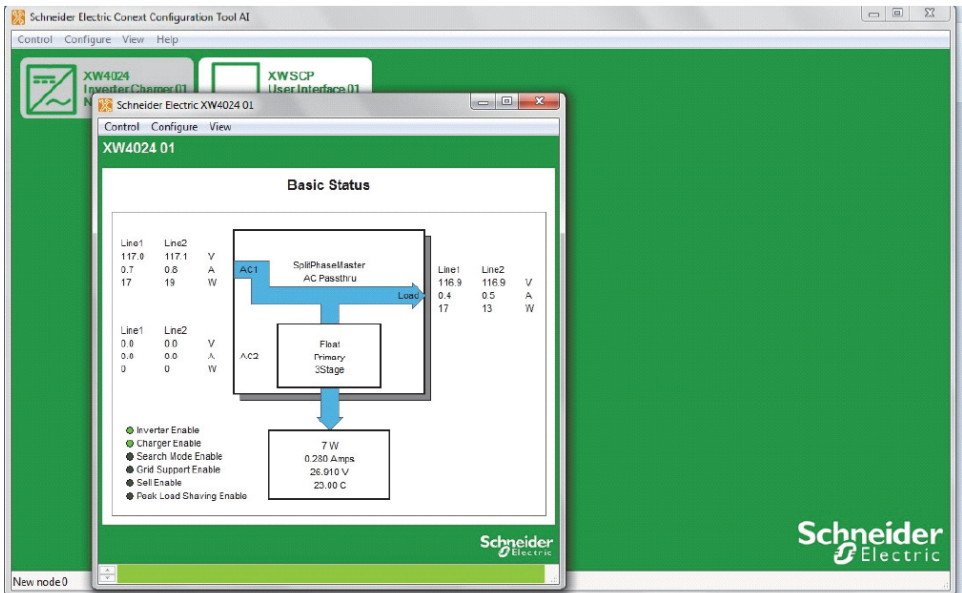

10. Go to **Configure -> Inverter -> Inverter Output**.

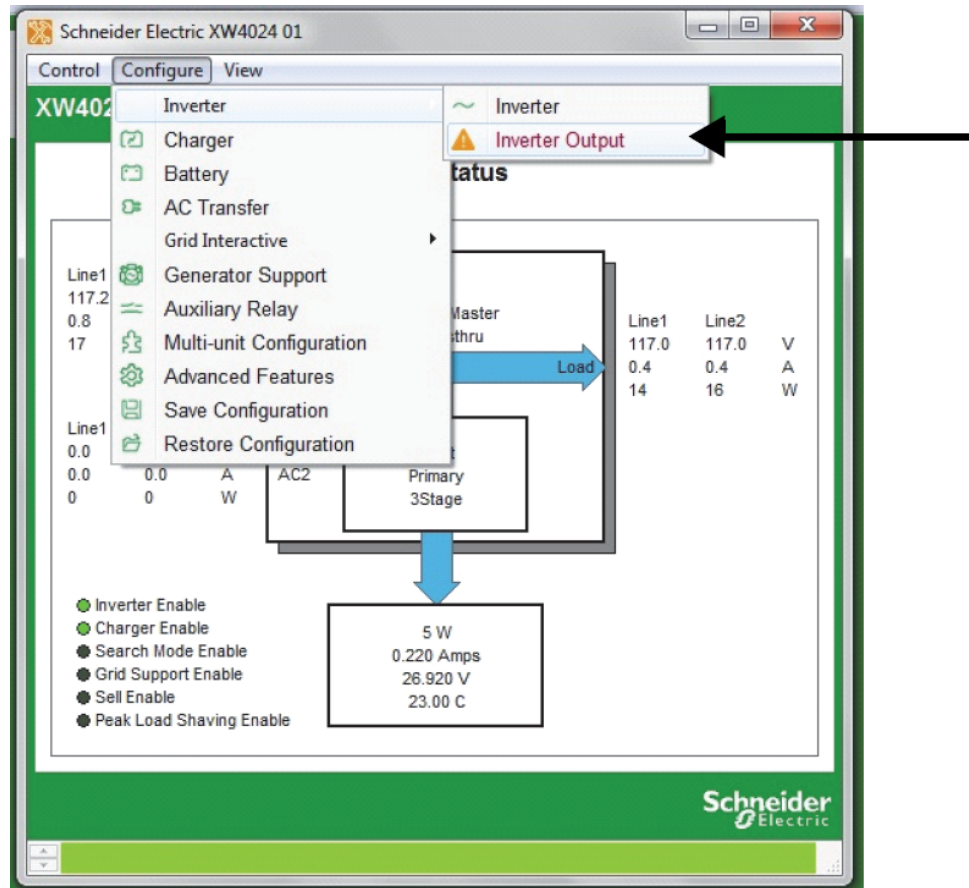

A WARNING message appears.

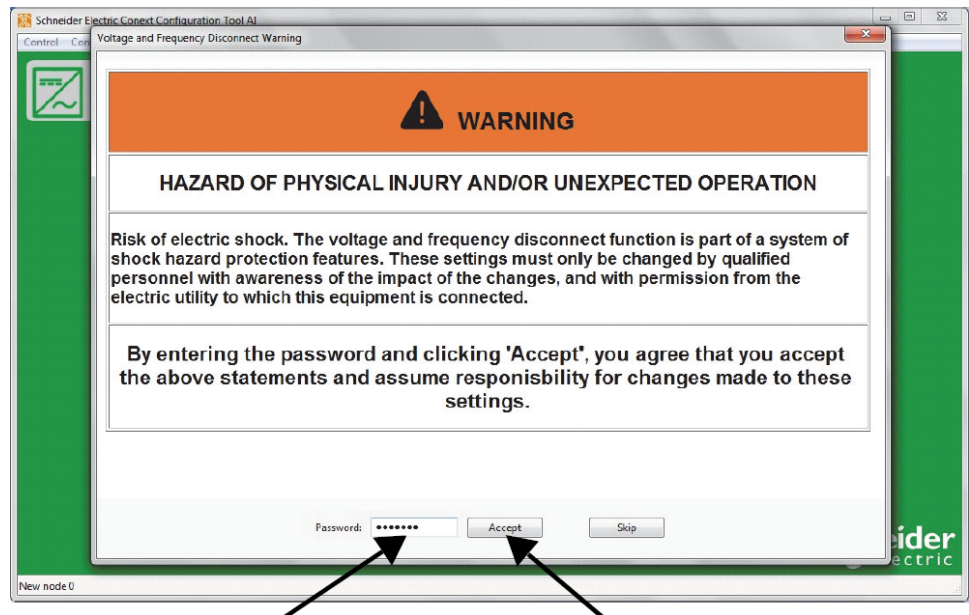

11. Enter the password and click **Accept**.
 NOTE: Hitting **Enter** does not work. You must click **Accept**.
 The Inverter Output Settings screen appears.

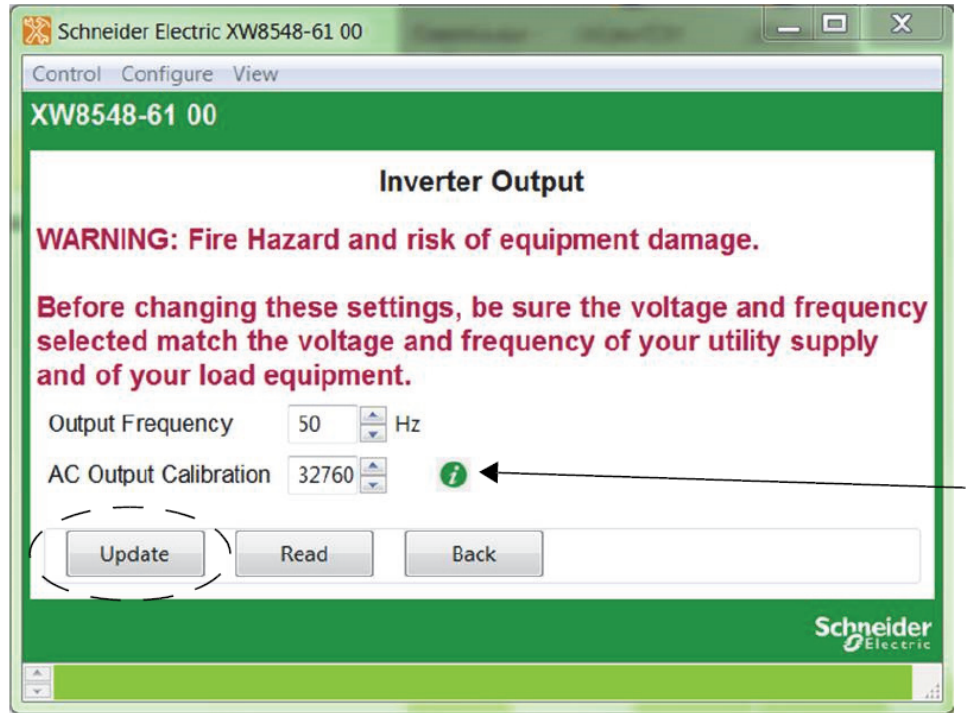

NOTE: To make the changes permanent, adjust the **AC Output Calibration** scaler value and the **Output Voltage** change will become permanent after the unit resets.

12. Adjust the **AC Output Calibration** number by setting the output voltage within $\pm 0.5V$ of the desired value (for example: 229.5 – 230.5 volts for a 230 V configuration). Use the voltmeter to measure the voltage.

System	Starting calibration count	increase count by	corresponding increase in voltage value
120 V	34000	140, 280	0.5 V, 1.0 V
120/240 V	33000	75, 140	0.5 V, 1.0 V
230 V	32650	75, 140	0.5 V, 1.0 V

If the firmware version being used is v1.02 BN005, for the XW Pro units designated to operate as Master, adjust the AC Output Calibration number so that the output voltage is 0.4 V to 0.6 V lower than designated Slave units.

13. Set the value by clicking the **Update** button.
14. Put the unit in **Standby**.
Important: If the XW Pro is a Master unit, then proceed to the next step. If it is a Slave unit which got changed to Master from Step 6, then reconfigure it back to Slave first before proceeding to the next step. To change the Inverter Mode go to:
Advanced Settings -> Multi-Unit Config -> Inverter Mode.
15. Turn On the next XW Pro unit to be calibrated and follow steps 5 through 14 for that unit.
16. Once all units have been calibrated, close all the AC output voltage breakers.

17. System is now calibrated.

Calibration with Load (Power Sharing/Balancing)

Important: This calibration procedure can only be done after the voltage calibration has already been done. It must be performed with loads connected and with battery power only. Disengage from grid power, if the XW Pro units are grid connected.

1. Perform the previous section, "*Calibration without Load*" on page 60.
2. After Step 16 of the previous section, turn On the load.

Important:

In a 120 V (or 230 V) single-phase setup, a load can be shared equally (within < 10% differential) by all paralleled XW Pro units.

In a 120/240 V split-phase setup, a load can be shared equally (within < 10% differential) by all paralleled XW Pro units.

In a three-phase setup, a load can be shared equally (within < 10% differential) by one phase.

3. Observe the power consumption of the load on the front panel display for all the XW Pro units (within the same phase).

Perform on Slave unit/s only:

If the Slave unit provides less power than the Master unit, meaning the power sharing is uneven, then increase the **AC Output Calibration** count number on the **Slave unit only** by 50 counts. For example, from **34000** to **34050**.

If the Master unit provides less power than the Slave unit, then decrease the **AC Output Calibration** count number on the **Slave unit only** by 50 counts. For example, from **34000** to **33950**.

4. Repeat Step 3 until load sharing is balanced between the units within < 10% differential.

Schneider Electric

As standards, specifications, and designs change from time to time, please ask for confirmation of the information given in this publication.

For other country details please contact your local Schneider Electric Sales Representative or visit the Schneider Electric Solar Business website at: <https://solar.schneider-electric.com>

© 2021 Schneider Electric. All Rights Reserved.