



COMMERCIAL

30K-3P-N

208V

INSTALLATION GUIDE | USER MANUAL



UL Model "30K-3P-208V" INSTALL GUIDE & OWNER'S MANUAL

UPON RECEIVING SHIPMENT	4
SPEC SHEET	5
WIRE GAUGE GUIDE (COPPER).....	7
WIRING DIAGRAMS	8
PHYSICAL INSTALLATION	18
INVERTER COMPONENTS.....	18
DECIDING THE SITE'S BACKUP CIRCUITS.....	18
SINGLE SYSTEM INSTALLATIONS (SMALL COMMERCIAL BACKUP)	19
MOUNTING THE SOL-ARK	19
INTEGRATING BATTERIES (SOL-ARK POWERED "OFF").....	19
CONNECTING SOLAR PANELS	20
INTEGRATING A GENERATOR.....	21
SENSORS INTEGRATION AND ACCESSORY PLACEMENT.....	22
POWERING-UP & TESTING THE SOL-ARK 30K-3P-208V	24
CHECK THE VOLTAGE ON EACH PV INPUT CIRCUIT	24
WI-FI / INTERNET CONNECTION.....	25
REMOTE MONITORING SETUP	25
IP ADDRESS SETUP INSTRUCTIONS (PC OR SMARTPHONE)	28
GUI SCREENS.....	30
PROGRAMMING GUIDE	32
MAIN SCREENS (TOUCHSCREEN)	33
BASIC SETUP	34
SYSTEM ALARMS.....	34
BATTERY SETUP	35
LIMITER TAB / GRID SETUP	37
LIMITER SENSORS (CT SENSORS).....	41
LIMITER SENSOR AUTOMATIC SETUP	41
INSTALL TIPS	43
OFF-GRID INSTALL TIPS	43
GRID-TIE / NO BATTERY INSTALL TIPS	43
BATTERIES	44
BATTERY CHARGING INFORMATION	44
TROUBLESHOOTING GUIDE.....	45
TROUBLESHOOTING PHASING ISSUES.....	47
SOL-ARK 30K-3P-208V ERROR CODES	48
INSTALL VERIFICATION CHECKLIST	49
30K-3P-208V LIMITED WARRANTY	50



Disclaimer

UNLESS SPECIFICALLY AGREED TO IN WRITING, SOL-ARK:

(a) MAKES NO WARRANTY REGARDING THE ACCURACY, SUFFICIENCY, OR SUITABILITY OF ANY TECHNICAL OR OTHER INFORMATION PROVIDED IN ITS MANUALS OR OTHER DOCUMENTATION.

(b) ASSUMES NO RESPONSIBILITY OR LIABILITY FOR LOSS OR DAMAGE, WHETHER DIRECT, INDIRECT, CONSEQUENTIAL, OR INCIDENTAL, WHICH MIGHT ARISE OUT OF THE USE OF SUCH INFORMATION. THE USE OF ANY SUCH INFORMATION WILL BE ENTIRELY AT THE USER'S RISK.



Sol-Ark cannot be responsible for system failure, damages, or injury resulting from improper installation of their products.

The information included in this manual is subject to change without notice.

Contact Us:

PHONE	1-972-575-8875 ext 2
EMAIL	SUPPORT@SOL-ARK.COM
WEBSITE	WWW.SOL-ARK.COM

Warning Symbols

	This symbol indicates information that, if ignored, could result in minor injury or damage to the equipment.
	This symbol indicates information that, if ignored, could result in serious injury, damage to the equipment, or death.
	This symbol indicates information that is important but not hazard-related.

Warnings



Read this entire document before installing or using the Sol-Ark 30K-3P-208V Inverter. Failure to follow the instructions or warnings in this document can result in electrical shock, serious injury, or death. Damage to the Sol-Ark Inverter is also possible, potentially rendering it inoperable.



High Life Risk Due to Fire or Electrocution – **ONLY** qualified personnel should install the Sol-Ark 30K-3P-208V Inverter.



The system must have Ground connections and Neutral connections. Ground **MUST** be bonded to Neutral **ONLY ONCE** in the circuit.



Solar PV+/PV- are **UNGROUND**. Note: you may ground **PV Racking/Mounts**, but doing so directly to the Sol-Ark will likely result in damage in the case of a direct lightning strike to the PV array. We recommend grounding the frames outside of the Sol-Ark circuit.



DO NOT connect the grid to the Load Output Terminal Block.



DO NOT reverse the polarity of batteries. Damage **WILL** occur.



DO NOT exceed 500Voc on any MPPT on the Sol-Ark.



DO NOT turn off the battery breaker if any current flows in or out of the battery.



DO NOT use impact drivers to tighten any fasteners on the Sol-Ark.



MUST use Strain Reliefs **ON ALL** wires entering/exiting the Sol-Ark 30K-3P-208V user area.



MUST use conduit (or double insulated wire) for AC Wires entering/exiting Sol-Ark 30K-3P-208V user area.



ALL terminals/breakers, including battery, MPPT, and AC Terminal Block inputs, should only have one conductor connecting to them.

Inspect Shipment

- A. Compare the package condition to the condition of the package in the photo we sent you before it left our facility.



You must note any damage due to shipping with delivery driver before accepting the package otherwise the shipping company will deny any claim.

- B. If damaged, contact us immediately at 972-575-8875 Ext. 3

Component Guide— the following items are included in the package:

- A. Sol-Ark 30K-3P-208V inverter (x 1)
- B. Mounting Bracket: For wall mounting the Sol-Ark 30K-3P-208V (x 1)
- C. Bolts M12x60 (x 4)
- D. Bolts M4x12 (x 9)
- E. CAT 5 cable for parallel communications (x 2)
- F. WIFI Dongle: For software updates and remote monitoring (use M4x10 screws to hold in)
- G. L-Type Hex Key (3mm): For opening and closing the user wiring area (x 1)
- H. Included Limiter Sensors: 1 3/8" CT sensors (x 3)
[Larger sensors available: email sales@sol-ark.com]
- I. T-Type Hex Key: For tightening the AC connections (x 1)

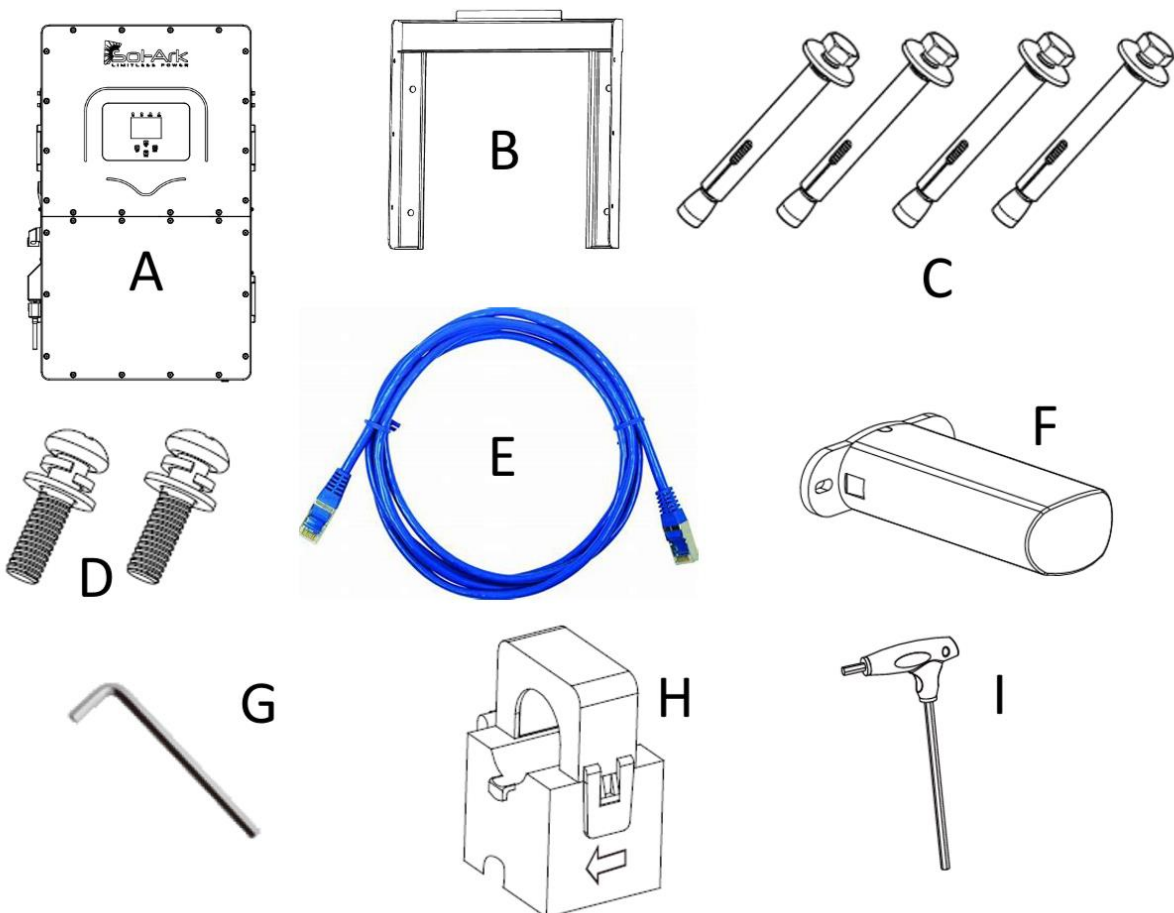



30K-3P-208V Spec Sheet



Battery (optional) Output Power 30,000W	
Type Number of Inputs	Li-Ion 2 Inputs
Nominal DC Input	> 300V
Capacity	50 — 9900Ah
Voltage Range	150V—500V
Continuous Battery Charging Output	100A (50A per Input)
Charging Curve	3-Stage w/ Equalization
Grid to Batt Charging Efficiency	96.0%
Battery Fuse	Integrated
Current Shunt for Accurate % SOC	Integrated
External Gen Start Based on Voltage or %SOC	Integrated
Communication to Lithium Battery*	CanBus & RS485

*ONLY works with Li-Batteries under Closed-Loop Communications

Solar Input Power 39,000W	
Max Allowed PV Power	39,000W
Max PV Power Delivered to Battery & AC Outputs	30,000W
Max DC Voltage (Voc)	500V @ 36A
MPPT Voltage Range	170-500V
Starting Voltage	150V
Number of MPPT	4
Max Solar Strings Per MPPT	2
Max DC Current per MPPT (Self Limiting)	36A
Max AC Coupled Input into the GEN terminal (Micro / String Inverters)	54kW w/ no PV _{DC} ** 30kVA w/ 39kW PV _{DC}

** Software Limitation: 180A x 120V x 3

General	
Dimensions (H x W x D)	35.2" x 20.8" x 11.6"
Weight	172 lbs
Enclosure	IP65 / NEMA 3R
Ambient Temperature	-40~60°C, >45°C Derating
Installation Style	Wall-Mounted
Wi-Fi & LAN Communication	Included
Standard Warranty (verified by HALT Testing)	10 years

AC Output Power 30,000W On & Off-Grid	
Connections	120V / 208V Three Phase
Continuous AC Power with PV	30,000W 83.4A (208V)
Continuous AC Power from Batteries	30,000W 83.4A (208V)
Surge AC Power 7 sec	45,000VA 125A (208V)
Parallel Stacking	Yes—Up to 12
Frequency	60/50Hz
Continuous AC Power with Grid or Generator	72,000W 200A L-L (208V) 36,000W 200A L-N (120V)
CEC Efficiency	96.5% (Peak 97.5%)
Idle Consumption Typical—No Load	60W
Sell Back Power Modes	Limited to Household/Fully Grid-Tied
Design (DC to AC)	Transformerless DC
Response Time (Grid-Tied to Off-Grid)	5ms
Power Factor	+/- 0.8 - 1.0

Protections & Certifications	
Electronics Certified Safety by TÜV Rheinland to NEC & UL Specs	Yes
Grid Sell Back — UL 1741-2021 3rd Edition (incl UL1741SB), CSA C22.2, IEEE 1547-2018 & 1547a-2020 & 1547.1-2020, UL1699B Arc-Fault Circuit-protection Type 1	Yes
PV DC Disconnect Switch — NEC 240.15	Integrated
Ground Fault Detection — NEC 690.5	Integrated
PV Rapid Shutdown Control — NEC 690.12	Integrated
PV Arc Fault Detection — NEC 690.11	Integrated
PV Input Lightning Protection	Integrated
PV String Input Reverse Polarity Protection	Integrated
Surge Protection	DC Type II / AC Type II

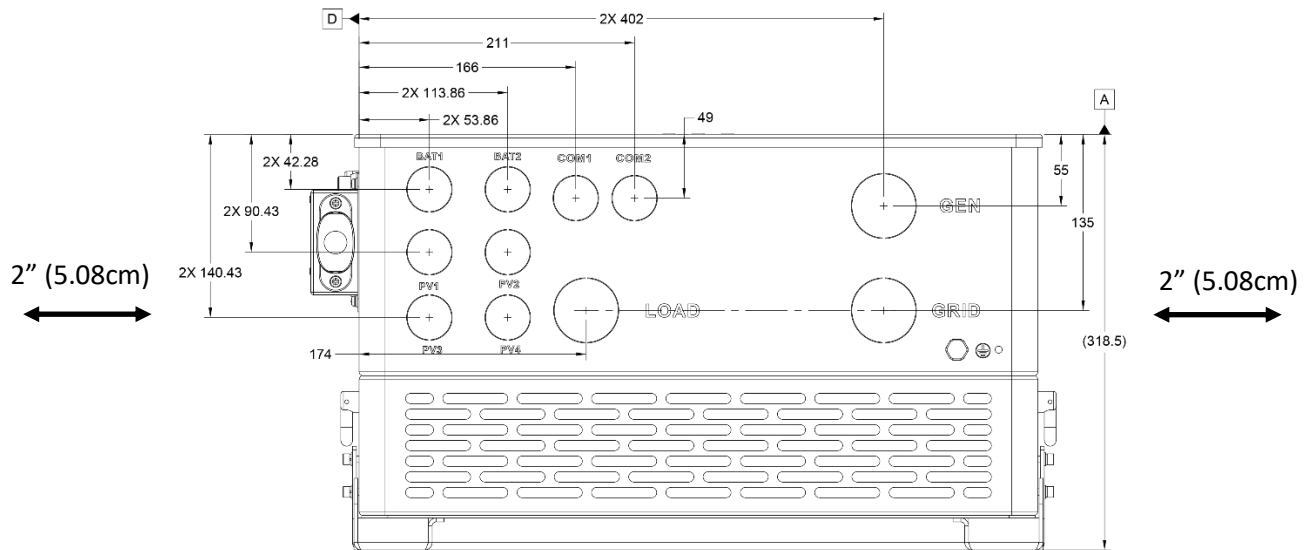
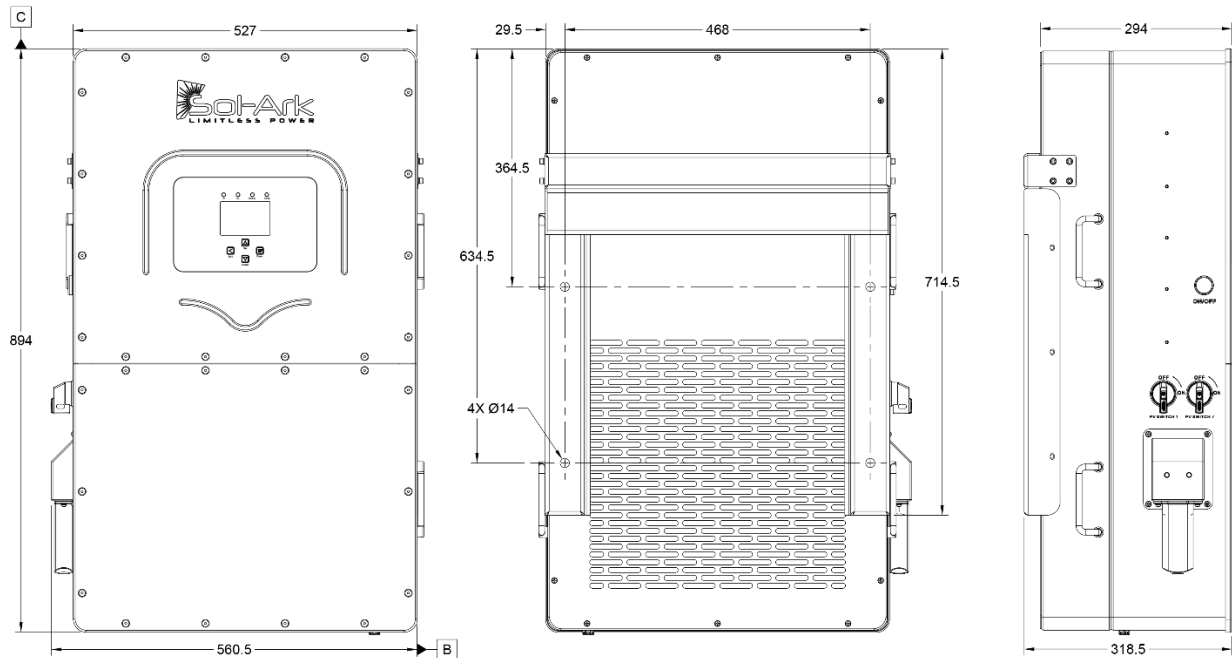

2" Minimum Horizontal Clearance | 6" Minimum Vertical Clearance

Temperature Derating
 DC: 90C-100C Shutdown @ 100C
 AC: 75C-82C Shutdown @ 82C

Sol-Ark 30K-3P-208V Torque Values Application Note

Load Terminal Block	62 IN Lbs	7 NM
Grid Terminal Block	62 IN Lbs	7 NM
Gen Terminal Block	62 IN Lbs	7 NM
Neutral / Ground Busbars	62 IN Lbs	7 NM
Cover Screws	15.5 IN Lbs	1.75 NM
Battery Connection	Hand-Pressed Actuation Lever	Hand-Pressed Actuation Lever

Do Not Use Impact Drivers to Tighten Any Fasteners on the Sol-Ark.

PV input: **12 - 10 AWG**

AC Inputs/Outputs: 1/0 AWG - **4/0 AWG**

All Sensors: **20 - 24 AWG**

CT Sensors: **10' Wire Included**

Batt Temp Sensor: **6' Wire Included**

RJ45 Cable: **7' Included (Extendable up to 20')**

Battery input: 6 - 4 AWG (Hand-Tightened Actuation Lever)

34.93mm (1 3/8in)

50.8mm (2in)

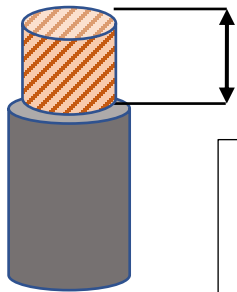
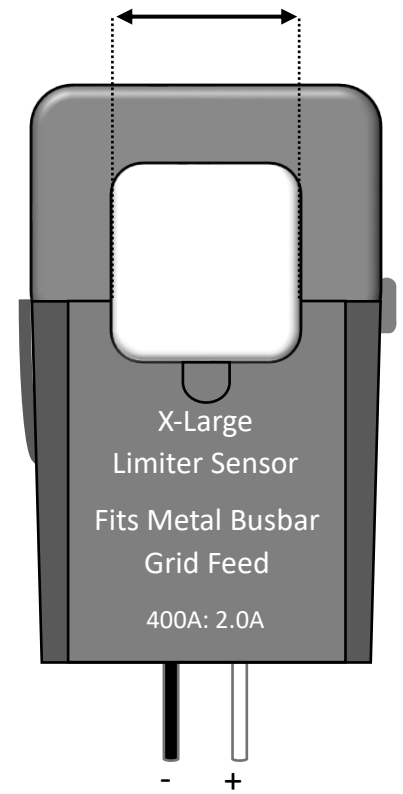
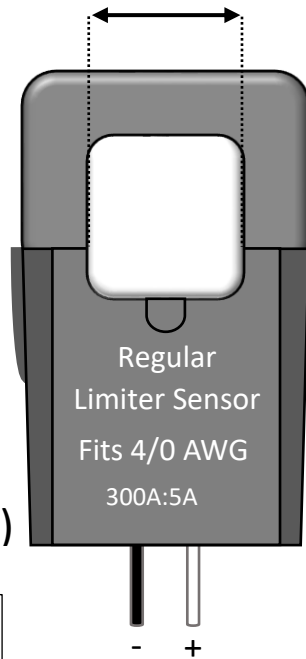

15.875mm (5/8in)

PV Panel Inputs
0' - 100': **12 AWG**
100' - 300': **10 AWG**

10 AWG Max

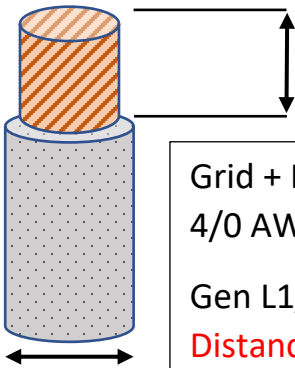

25.4mm (1in)

Grid + Load L1/L2/L3, Ground, & Neutral:
4/0 AWG
Gen L1/L2/L3, Ground, Neutral: **2/0 AWG**
Distance Limits Will Vary Per User ⚠️

4/0 AWG Max

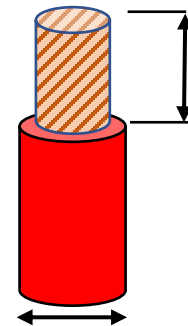

25.4mm
(1in)

DC Battery Input
0' - 12': **6 AWG**
12' - 20': **4 AWG**

4 AWG Max



6.35mm
(1/4in)

20 AWG Max

All Sensor Inputs

0' - 100': **24 AWG (Do NOT use > 20AWG)**

100' - 400': **23 AWG CAT 6**

CT Wires Can Be Extended -Extensions for Limiter Sensors must be twisted pair (See pg. 41)

(Shielded CAT6 Recommended)



These Wiring Diagrams are examples of common-use cases for Sol-Ark inverters.

Sol-Ark does not provide custom diagrams; however, you may contact support@sol-ark.com for any questions about existing Wiring Diagrams.

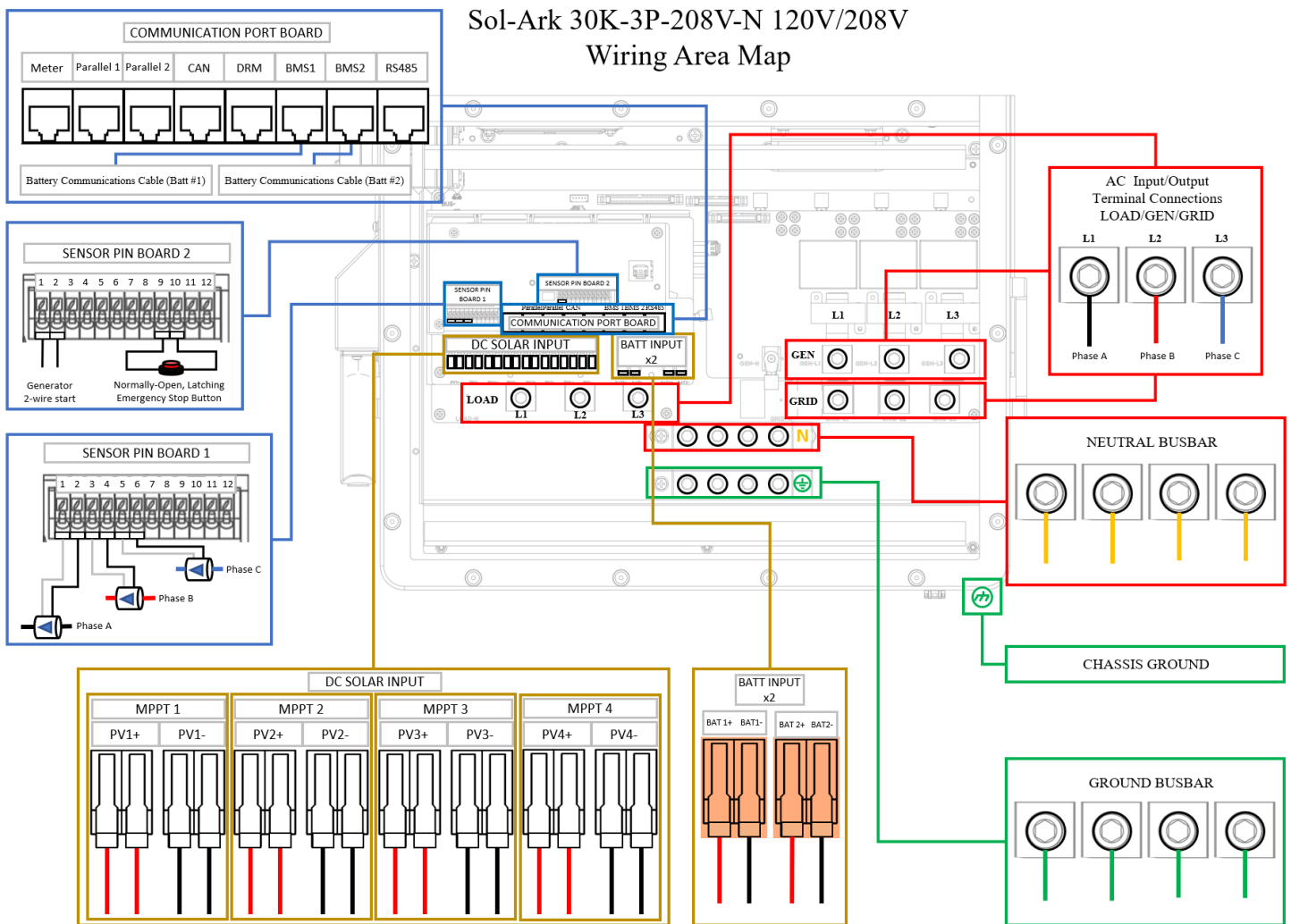
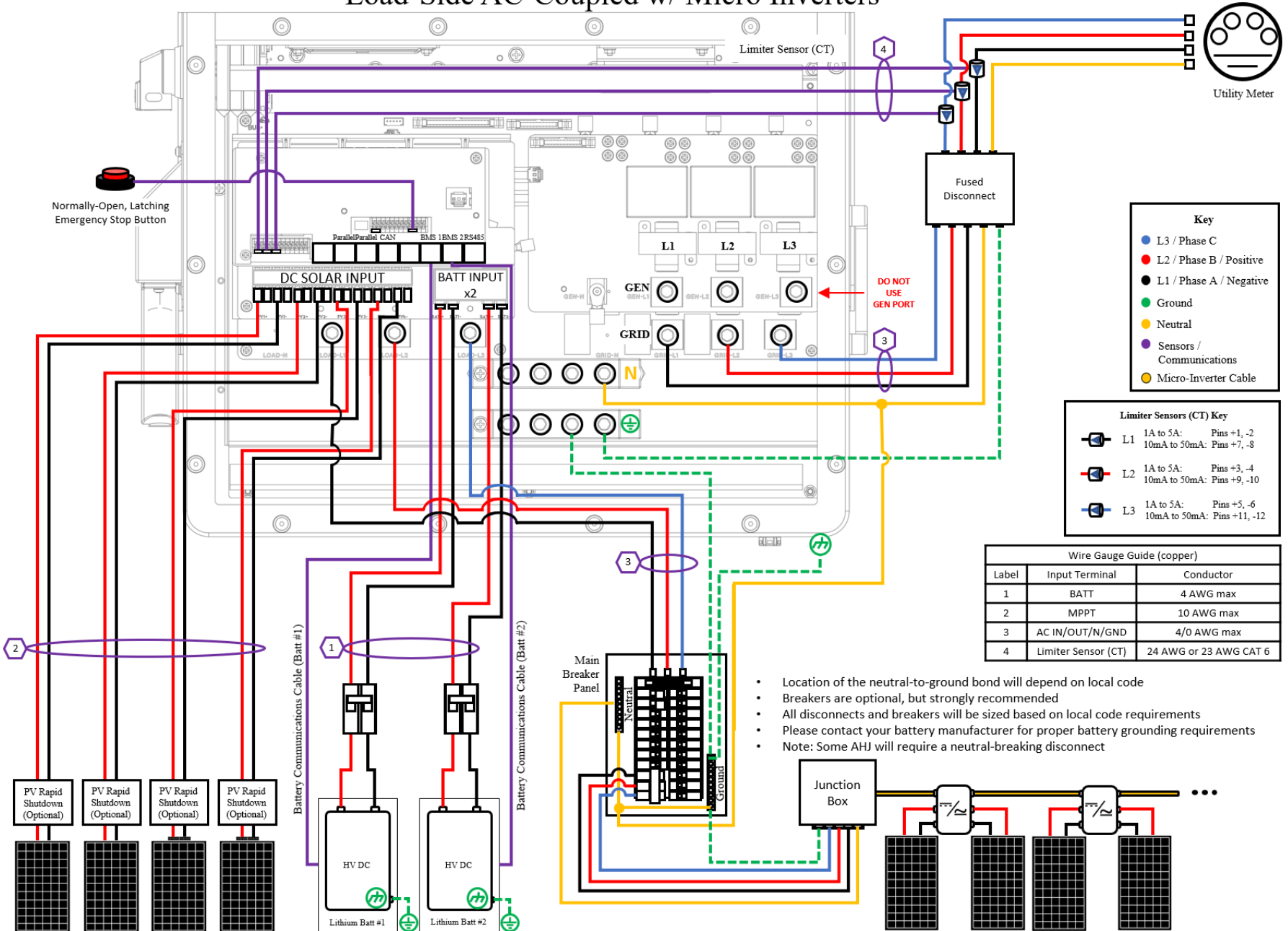

Diagram 1

Sol-Ark 30K-3P-208V-N Standard Wire Diagram 120V/208V Load-Side AC-Coupled w/ Micro Inverters



Key

- L3 / Phase C
- L2 / Phase B / Positive
- L1 / Phase A / Negative
- Ground
- Neutral
- Sensors / Communications
- Micro-Inverter Cable

Limiter Sensors (CT) Key

- L1 1A to 5A: Pins +1, -2
10mA to 50mA: Pins +7, -8
- L2 1A to 5A: Pins +3, -4
10mA to 50mA: Pins +9, -10
- L3 1A to 5A: Pins +5, -6
10mA to 50mA: Pins +11, -12

Wire Gauge Guide (copper)

Label	Input Terminal	Conductor
1	BATT	4 AWG max
2	MPPT	10 AWG max
3	AC IN/OUT/N/GND	4/0 AWG max
4	Limiter Sensor (CT)	24 AWG or 23 AWG CAT 6

- Location of the neutral-to-ground bond will depend on local code
- Breakers are optional, but strongly recommended
- All disconnects and breakers will be sized based on local code requirements
- Please contact your battery manufacturer for proper battery grounding requirements
- Note: Some AHJ will require a neutral-breaking disconnect

Sol-Ark 30K-3P-208V-N Standard Wire Diagram 120V/208V GEN-Side AC-Coupled w/ Micro Inverters

Note: PV fuses are only required for >2 strings per MPPT

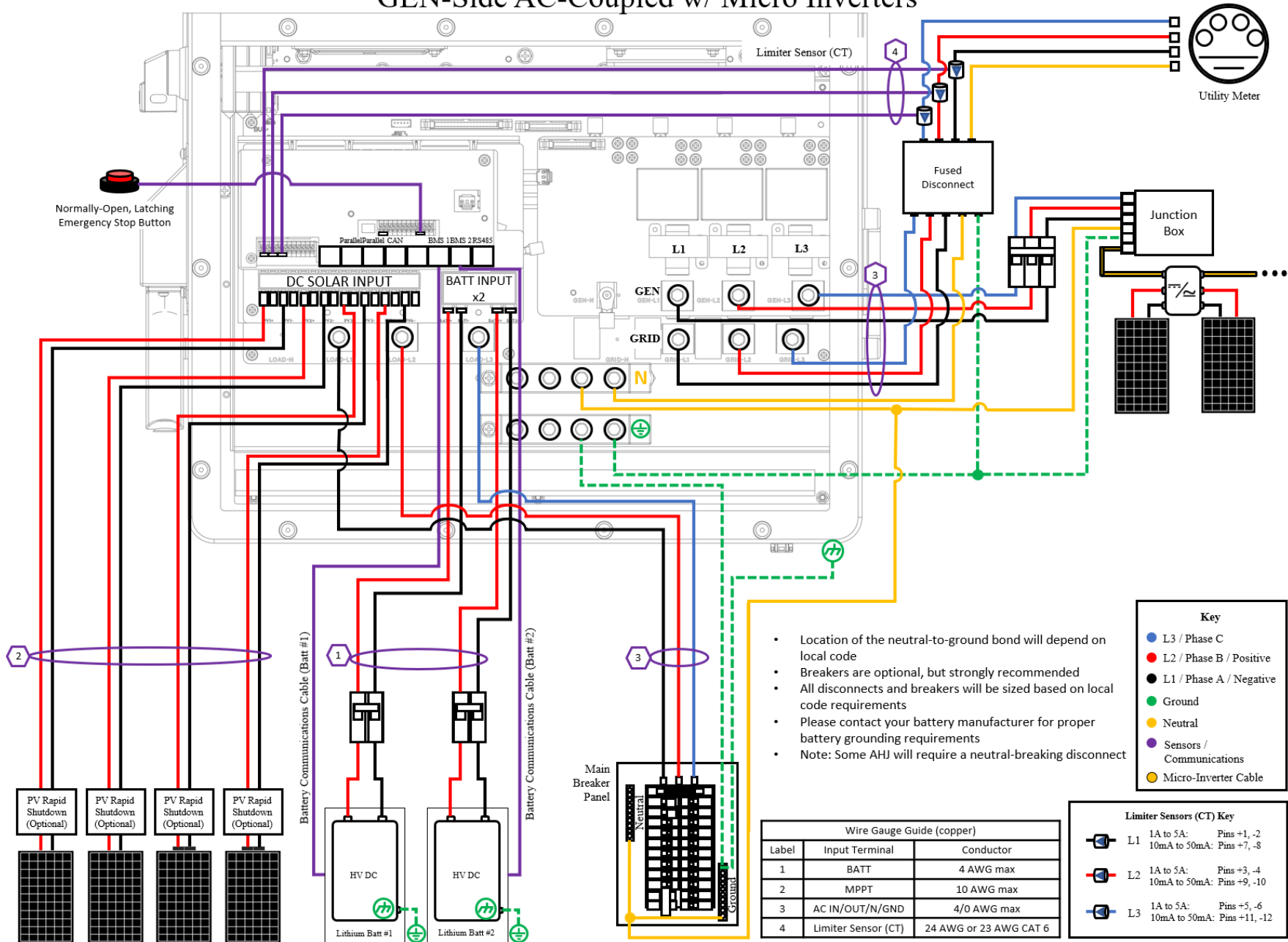

- Location of the neutral-to-ground bond will depend on local code
- Breakers are optional, but strongly recommended
- All disconnects and breakers will be sized based on local code requirements
- Please contact your battery manufacturer for proper battery grounding requirements
- Note: Some AHJ will require a neutral-breaking disconnect

Key

- L3 / Phase C
- L2 / Phase B / Positive
- L1 / Phase A / Negative
- Ground
- Neutral
- Sensors / Communications
- Micro-Inverter Cable

Wire Gauge Guide (copper)		
Label	Input Terminal	Conductor
1	BATT	4 AWG max
2	MPPT	10 AWG max
3	AC IN/OUT/N/GND	4/0 AWG max
4	Limiter Sensor (CT)	24 AWG or 23 AWG CAT 6

Limiter Sensors (CT) Key

- L1 1A to 5A: Pins +1, -2
10mA to 50mA: Pins +7, -8
- L2 1A to 5A: Pins +3, -4
10mA to 50mA: Pins +9, -10
- L3 1A to 5A: Pins +5, -6
10mA to 50mA: Pins +11, -12

Sol-Ark 30K-3P-208V-N Standard Wire Diagram 120V/208V Grid-Tied Only with Standby Generator

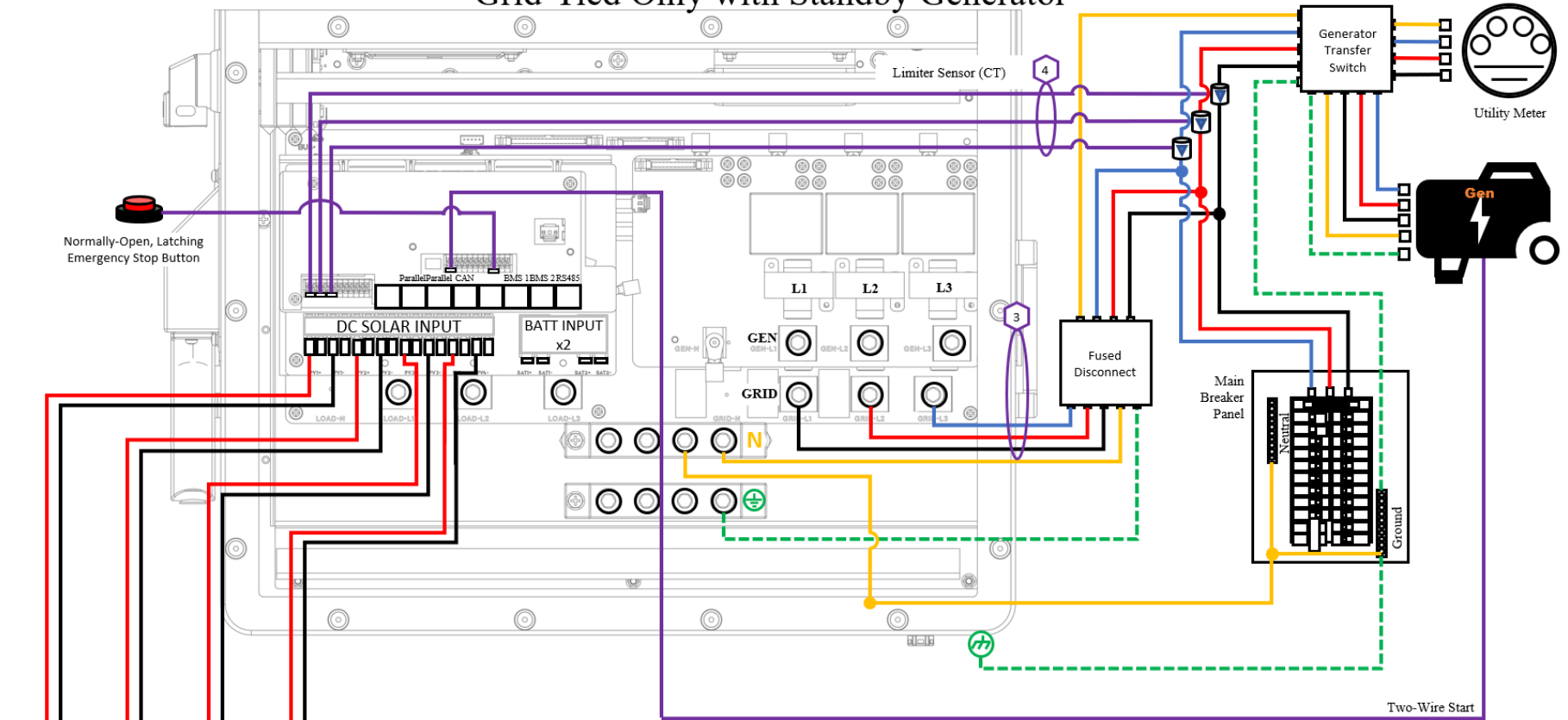

- Location of the neutral-to-ground bond will depend on local code
- Additional breakers are optional, but strongly recommended
- All disconnects/breakers/transfer switches will be sized based on local code requirements
- Note: Some AHJ will require a neutral-breaking disconnect

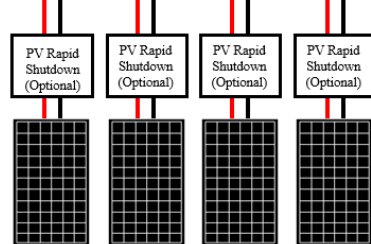

Key

- L3 / Phase C
- L2 / Phase B / Positive
- L1 / Phase A / Negative
- Ground
- Neutral
- Sensors / Communications

Limiter Sensors (CT) Key

L1	1A to 5A: Pins +1, -2 10mA to 50mA: Pins +7, -8
L2	1A to 5A: Pins +3, -4 10mA to 50mA: Pins +9, -10
L3	1A to 5A: Pins +5, -6 10mA to 50mA: Pins +11, -12

Wire Gauge Guide (copper)

Label	Input Terminal	Conductor
1	BATT	4 AWG max
2	MPPT	10 AWG max
3	AC IN/OUT/N/GND	4/0 AWG max
4	Limiter Sensor (CT)	24 AWG or 23 AWG CAT 6

Sol-Ark 30K-3P-208V-N x2 Standard Wire Diagram 120V/208V With Bypass Transfer Switch

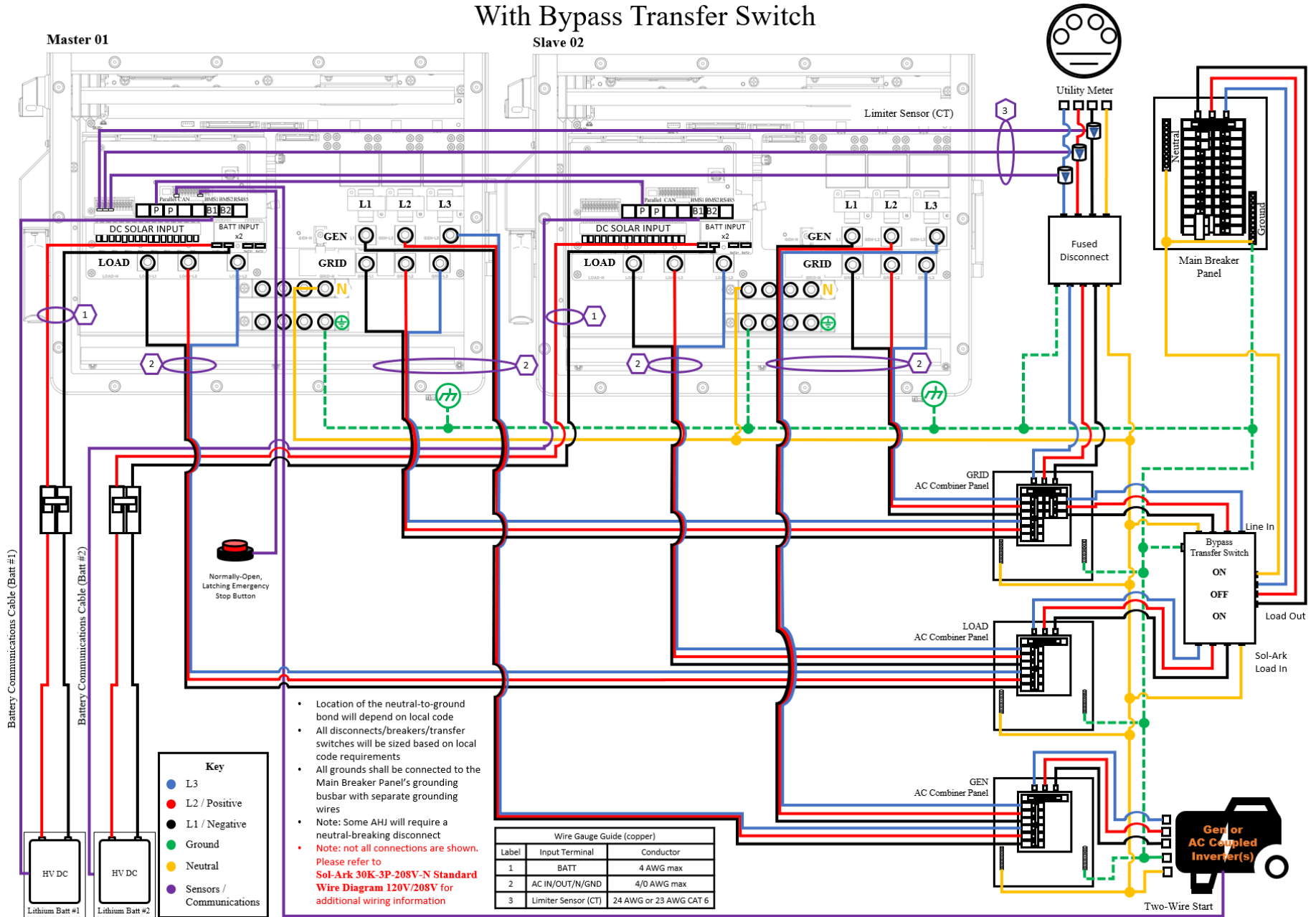

Note: Before powering up Parallel System installs, please see Pg. 46

Sol-Ark 30K-3P-208V-N x3 Standard Wire Diagram 120V/208V With Bypass Transfer Switch

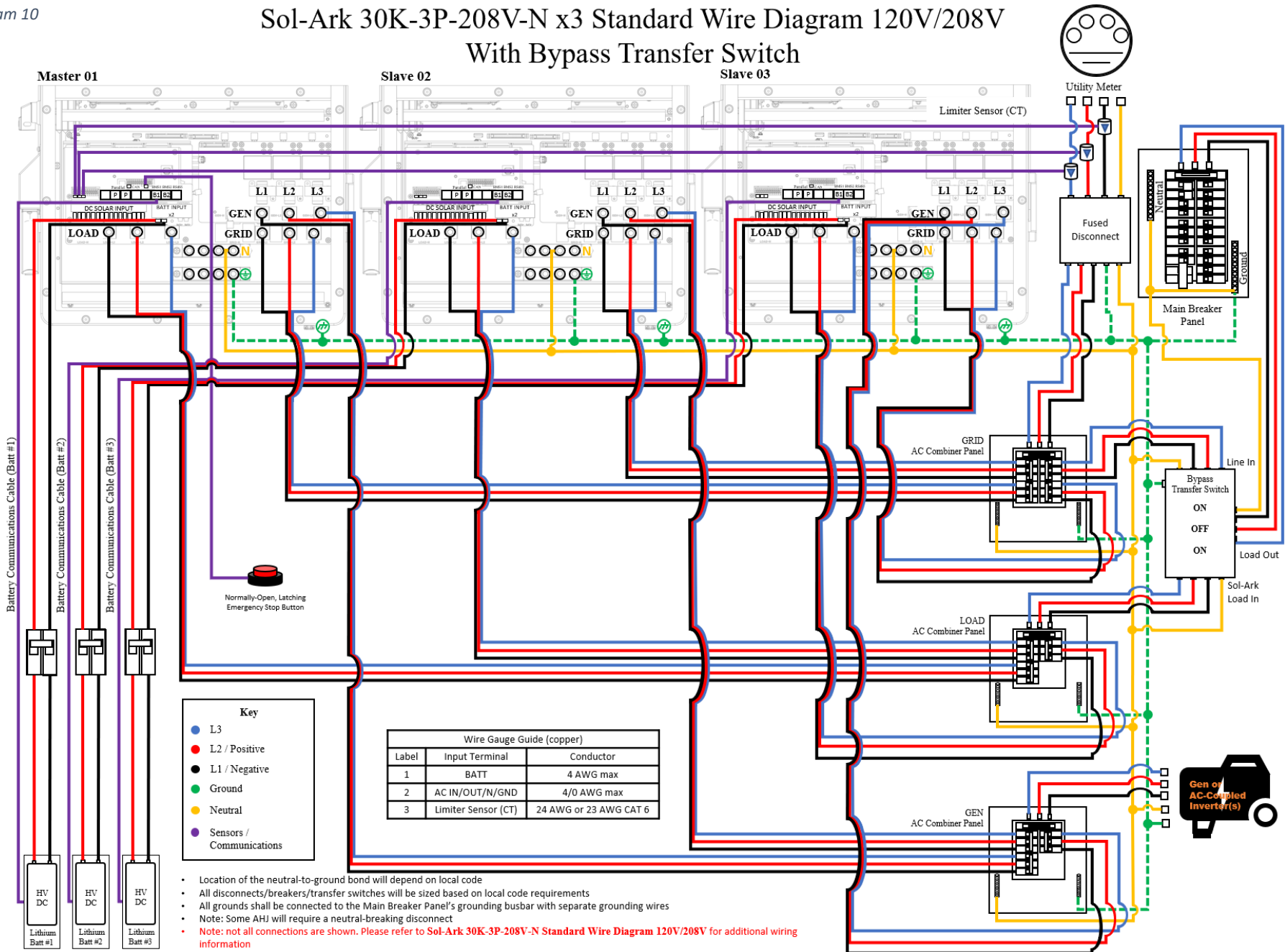

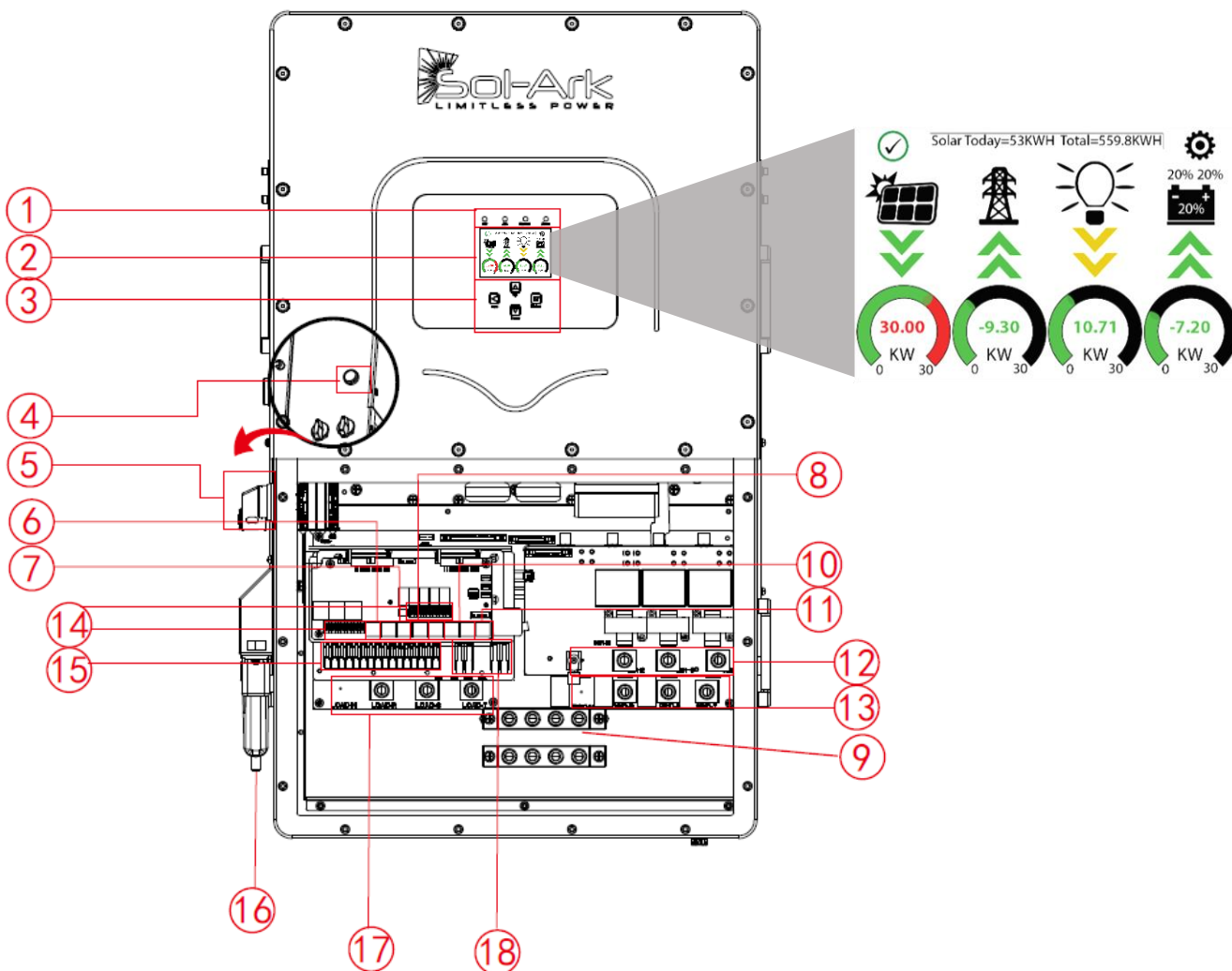

Note: Before powering up Parallel System installs, please see Pg. 46

Inverter Components



1.	Inverter Indicators	2.	LCD Display (Touch)	3.	Function Buttons
4.	ON/OFF Button	5.	2 x PV Disconnect	6.	Meter Port (optional)
7.	Parallel Port	8.	CAN Port	9.	Ground / Neutral Bars
10.	BMS Port	11.	RS485 Port	12.	Generator Input
13.	Grid Connection	14.	Function Port	15.	PV Input MPPTs
16.	Wi-Fi Interface	17.	Load Connection	18.	Battery Connections

Deciding the Site's Backup Circuits

- A. Ensure you keep the Inverter within its amperage limits
 - ON-Grid = 200A passthrough (160A software limitation)
 - OFF-Grid = 30kW = 83.4A Continuous | 45kVA = 125A Peak (10s)
- B. Verify each load circuit by measuring typical and max Amps with a clip-on Amp meter. Amps x 120V = Watts
-  C. Install a subpanel for backup loads if there is a chance of exceeding any amperage limits while powering the entire site off-grid; failure to do so will result in an outage and potential damage to the Inverter
-  D. If you have Arc-Fault / GFI breakers, DO NOT use a multi-circuit transfer switch.

Single System Installations (Small Commercial Backup)

- Use the output from 200A Fused Disconnect (from the grid) for the Grid input connection to the Sol-Ark
- Connect the Load output from the Sol-Ark directly to the Main Service Panel (at least 2/0 AWG)
- Connect a Generator (150A @ 120V x3) or AC-Coupled system to the GEN terminal blocks

Mounting the Sol-Ark

- Keeping in mind Sol-Ark's dimensions, find a suitable location for the system(s)
- NEMA 3R rating for Outdoor installations
- PROTECT the LCD screen from excessive UV exposure**
- System weight = 172 lbs (78kg). **Securely attach to the wall.** You may affix a mounting board to studs using 6-8 long wood screws
- Use the four (4) bolts + washers provided to mount the French Cleat to the board/wall
- Mount Sol-Ark on the installed French Cleat / Ensure Sol-Ark is level and sits properly
- Secure with the six (6) small screws (from 9 provided) for both sides of the French Cleat

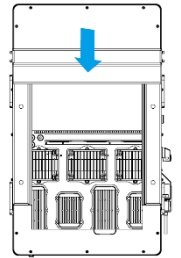
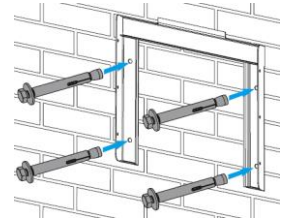

Integrating Batteries (Sol-Ark POWERED "OFF")

- Connect batteries to Sol-Ark as shown below
- Ensure the external battery disconnect is OFF while connecting batteries, or arcing may occur
- The 30K-3P reaches a maximum of 100A battery charge/discharge when using both battery terminals. When using one set of terminals, the max battery charge/discharge is **50A**



Multi-System Installs*

Please contact Sol-Ark technical support for parallel operation details.



Do NOT pull actuation levers more than 45 degrees away from vertical when installing the batt cables

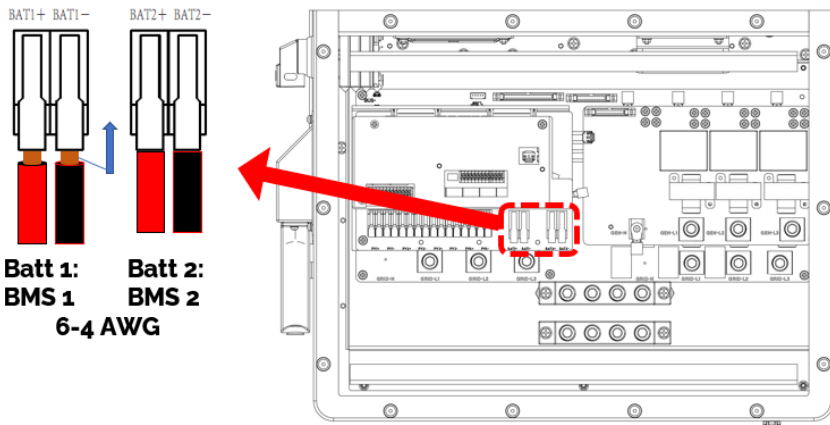

Sol-Ark 30K-3P-208V is a **High Voltage Battery** system. Do NOT wire the battery bank to any other nominal voltage.

When using 48V batteries, do not exceed eight (8) batteries in series.

Stay within the voltage range:
MIN 160V-MAX 500V

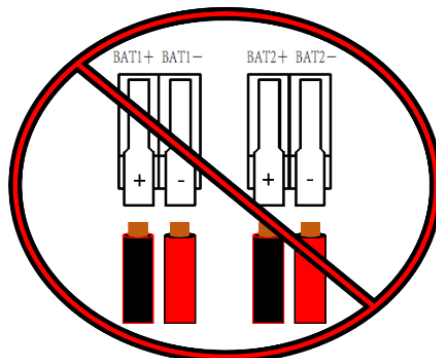

Do NOT reverse polarity of batteries!
Damage will occur!

Multi-Terminal Multi Lithium Install

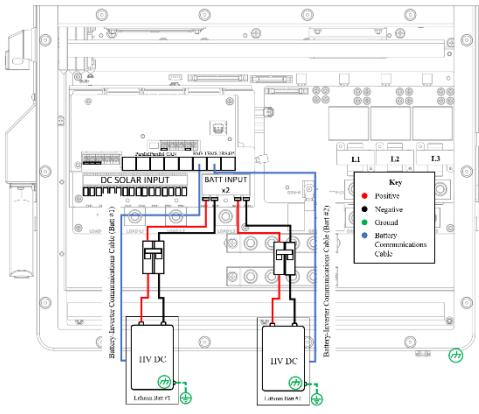

Note: Each pair of battery terminals is rated for 50A, so Lithium Batt #1 and Lithium Batt #2 will each receive up to 50A of charge and discharge

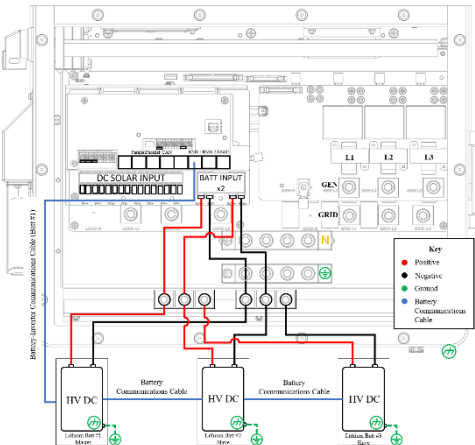

If using the paralleled Lithium Batts of the same make and model, then remove "Battery-Inverter Communications Cable (Batt #2)".

Multi-Terminal Single Battery Install

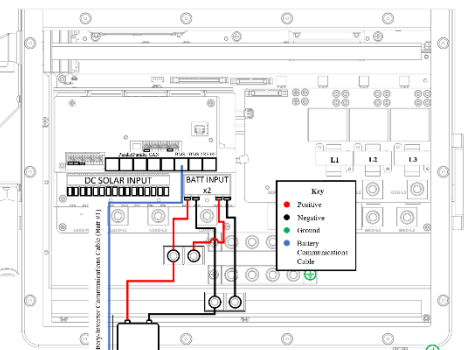

Use the "Multi-Terminal Single Battery" install if your single battery bank has a max charge/discharge current >40A, up to a total of 100A.

Check Battery Integration Guide for specific instructions on Closed Loop Comm Integration: www.sol-ark.com/support/

Connecting Solar Panels

- A. Sol-Ark has QUADRUPLE (4) MPPTs for four separate PV input pairs (~8 strings)
- B. MAX PV input = 39kW (± 5%) / system | 9.75kW / MPPT | MAX 500V_{oc} PV | MAX I_{sc}/MPPT 44A (limiting to 36A)

⚠ Damage will occur if PV V_{oc} > 500V

- C. **Parallel strings per MPPT must be the same Voltage**
 - i. PV1 A/B must be the same voltage if using all two (2) strings
 - ii. Arrays on the same MPPT CAN face different directions
- D. Ground the panel MOUNTS/FRAMES to any ground **outside** the circuit via 12AWG wire
- E. **IF using Y-Connectors: Running two strings in parallel, totaling 36A (self-limiting)**
- F. Connect the solar panel strings as indicated by the following diagram:

⚠ Each string **can** use separate wires
String minimum is usually 5 panels or 150V

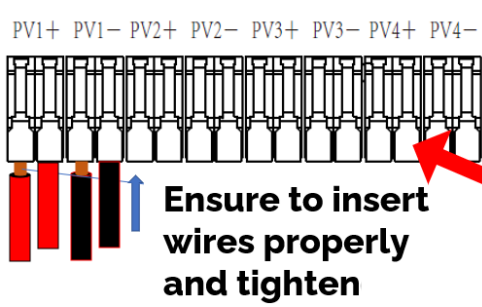

Maximum combined Output (AC+DC) = 72kW
54kW AC + 30kW DC

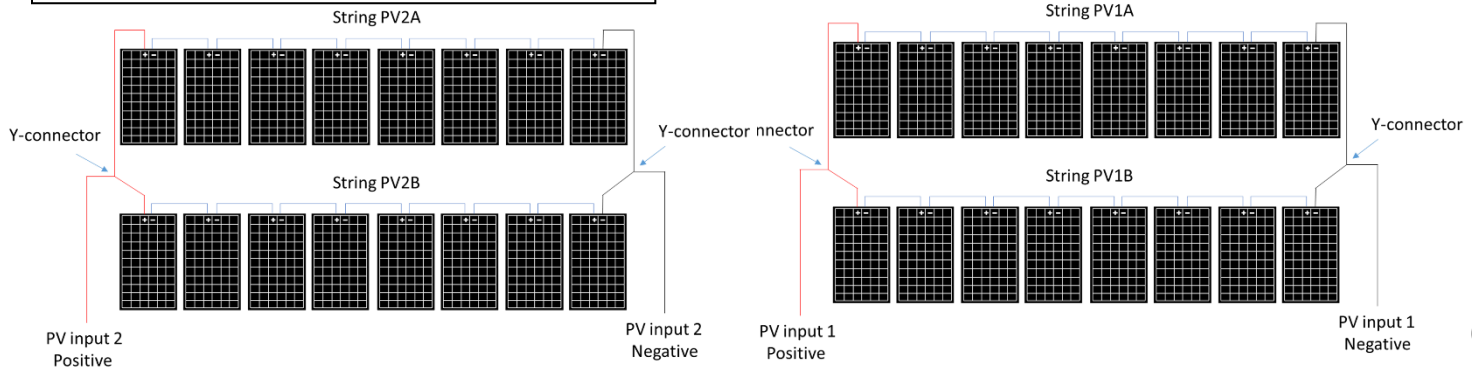
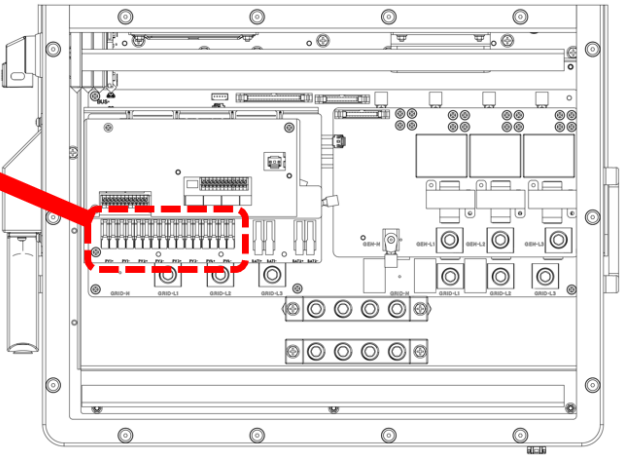

The Generator input must have a Neutral (WYE Configuration)

Integrating a Generator

Generator < 54kW (GEN Terminal)

- A. ONLY supports 208V_{AC} (3-phase) generators | 200A Terminal Block [Limited to 180A@120Vx3]
- B. Connect the generator output to the "GEN" input terminal block in the Sol-Ark 30K-3P-208V user area.
 -  GEN input doesn't support Split-Phase Generators.
- C. THD of less than 15% is preferred but not required

Standby Generators > 54kW (GRID Terminal) (OFF-GRID Recommendation)

- A. Supports 208V_{AC} (3-phase) generators | 200A Terminal Block (up to 72kW passthrough)
- B. Off-Grid / Standby Generator on ATS installations requires selecting "GEN Connected to Grid Input"
 - Home Screen → Gear Icon → Limiter → Other → GEN Connected to Grid Input
- C. Off-Grid = turn "Grid Sell" off | Only need CTs (on Gen lines) if using Grid Peak Shaving (see below)



Increase Gen/Sol-Ark Efficiency

1. Select "Limited Power to Load"
2. Select "General Standard"
3. Increase Grid frequency range: 55-65Hz

Grid Peak Shaving Mode (For Gen Connected to Grid terminals)

- A. It prevents the Sol-Ark from overloading generators
- B. Must place the CT sensors so that they measure L1/L2/L3 of the generator's output, pointing arrows on the CTs towards the inverter
- C. Sol-Ark contributes power above the "Power" value threshold to prevent overloading the generator
- D. This mode will auto-adjust the Grid Charge Amperage to avoid overloads

Gen Start V or % (Grid Start if Gen is on Grid Input)

The value batteries need to reach **BEFORE** automatically starting a generator connected to the GEN terminals to charge the battery bank.



Sol-Ark will **ONLY** charge batteries from a generator once the batteries reach this value.

Gen Start A (Grid Start A if Gen is on Grid terminals)

This is how many amps (DC) you can push from the generator to charge the batts. You will want to adjust the GEN or GRID Start A value to ensure you do not overload a small Generator. **Multiply value by # of Sol-Arks for actual current value into batteries.**



Suppose PV production = 0W | Disabled TOU | Enabled Grid/Gen Charge: The batteries will be charged to "full" using the Grid or a Generator (if available) until the battery bank accepts only 5% of its rated capacity in Amperes. This value correlates to roughly 90-93% full for most batteries and is the generator's default "OFF" signal. If producing PV, the system will use PV to charge the batteries to 100% full instead.

Sensors Integration and Accessory Placement

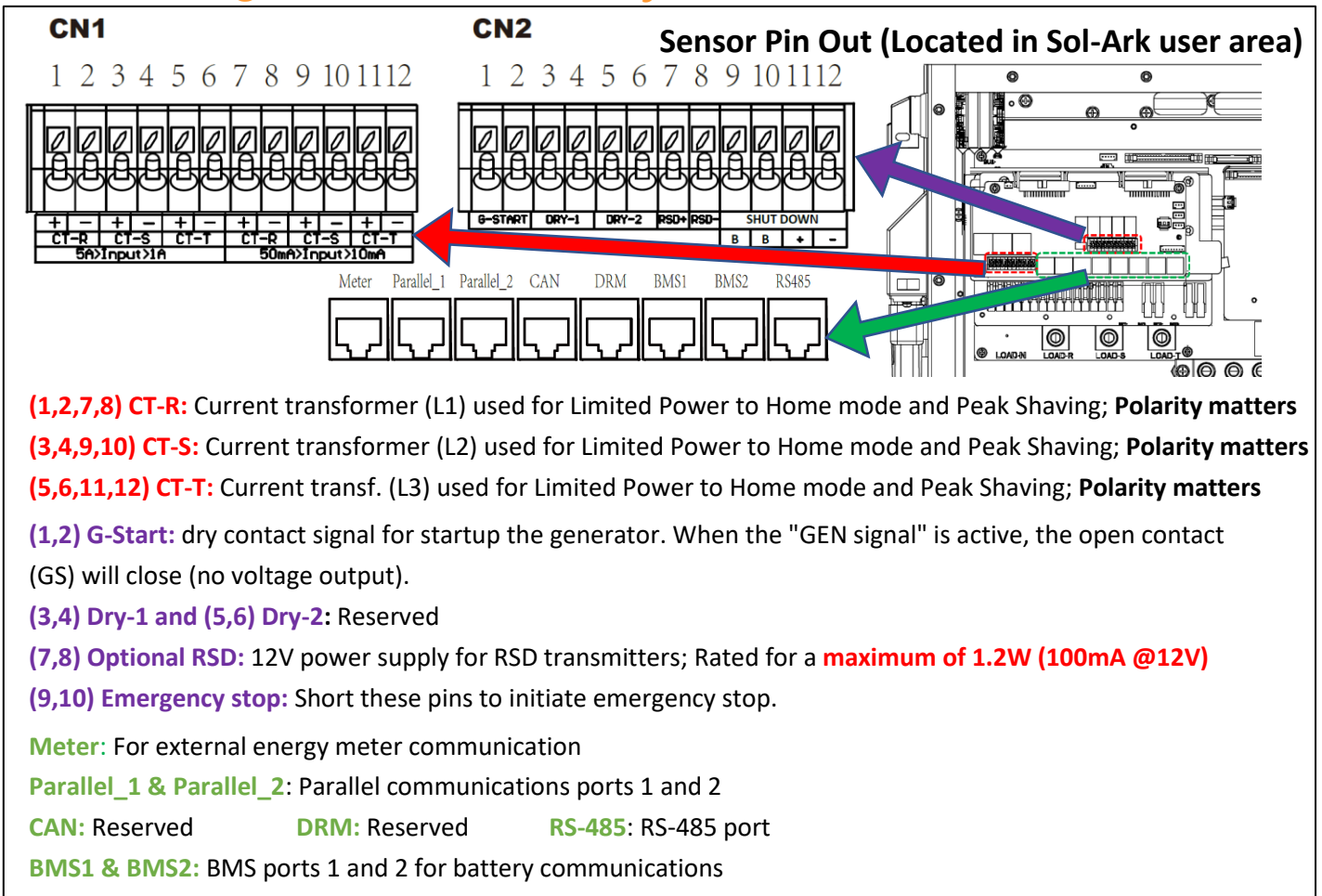

Limiter Sensors (CT Sensors) (diagram to the right)

- Install sensors on incoming electrical service wires L1, L2, & L3 (see Diagrams Section)
- Limited Power to Home Mode (meter zero) and Peak Shaving Modes require CT sensors
- To ensure the sensors will fit, please check the wire size before ordering (regular CTs accommodate up to 4/0 AWG) [Larger available: sales@sol-ark.com]
- See pg. 41 for additional CT sensor information.

GEN Start Signal (Two-Wire)

- The signal comes from a normally open relay that closes when the Gen Start state is active

CANbus & RS485

- To connect batteries to the Sol-Ark 30K-3P-208V via RJ45, you need to splice the end connecting to the 30K
- Use the middle two conductors
- RS485 is SunSpec draft 4 (will not work with draft 3)

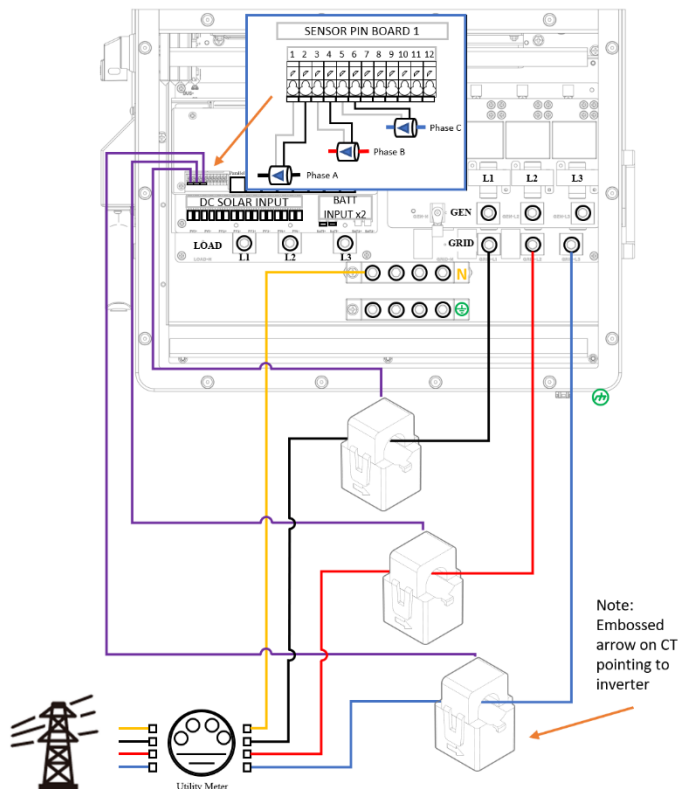

Wi-Fi Antenna (Dongles)

Remote monitoring and software updates require an internet connection through the Wi-Fi dongle (ethernet available)

Emergency Stop Signal & PV Rapid Shutdown Signal

Pins 9(B) and 10 (B) in the sensor pinboard 2 use an ordinarily open & latching switch to connect the two emergency stop pins that cut off the RSD power supply when triggered, thus stopping the inverter AC output.

Pins 7 and 8 in the sensor pinboard 2 provide the 12V / 100mA signal power lost when the Sol-Ark shuts down using the front button.

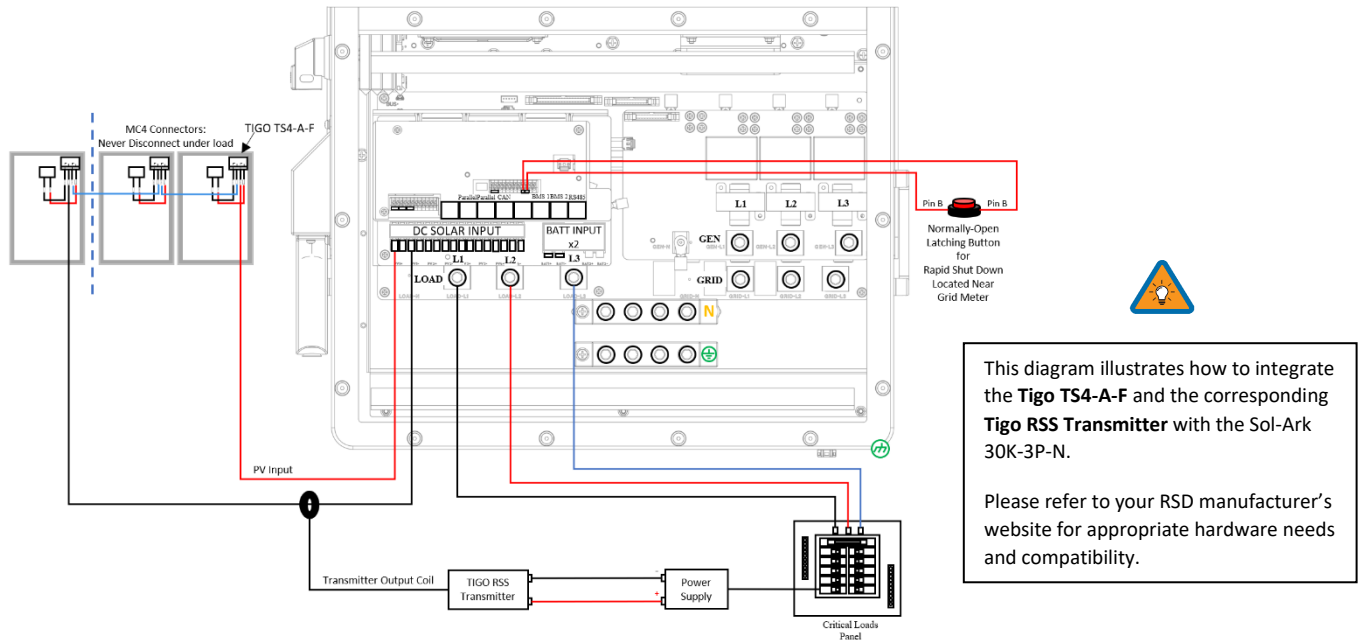

Rapid Shutdown: TIGO TS4-A-O | TIGO TS4-A-F | TIGO TS4-O | TIGO TS4-O-DUO | APsmart RSD S-PLC / RSD-D

PARALLEL SYSTEMS: Emergency Stop should be connected to the Master with address 01 and will initiate emergency stop for all paralleled systems from the one button



- The Built-in 12V power supply in the user area of the Sol-Ark (Pins 7 and 8) is rated for 100mA (1.2W).
- Transmitter fits inside the user area of the Sol-Ark 30K-3P-208V but can cause interference (sometimes requires placing it outside of the user area).
- TIGO Optimizers are compatible with the Sol-Ark 30K-3P-208V (**Do not** use the built in 12V Power supply in the Sol-Ark user area to Power the Tigo Optimizer TX transmitter).

If you are unsure whether the transmitter power supply is compatible with pins 7 & 8 of the inverter, contact the RSD manufacturer

Powering-Up & Testing the Sol-Ark 30K-3P-208V

Check the voltage on each PV input circuit

- A. It should be no higher than 500V_{oc} Temp. corrected
-  **B. DO NOT connect PV+ OR PV- to GND**
- C. Verify polarity (backward polarity shows 0V)

Check Grid Input Voltage

- A. Measure L1, L2, & L3 to Neutral. Ensure 120V_{AC}
- B. Measure L1/L2, L1/L3, L2/L3. Ensure 208 V_{AC}
- C. Check Neutral and Ground are ~0 V_{AC}
- D. Verify L1 voltage on AC in/out is 0 V_{AC} with the main L1 connection in the panel. Same for L2 & L3

Check Battery Voltage

- A. Turn on the battery switch (if using a Lithium battery)
- B. Turn on the external battery disconnect
- C. The voltage should be nominal 300V_{DC} [150V_{DC} ~ 500 V_{DC}]

Provide Power to Sol-Ark

- A. Turn on the Grid disconnect and Load Breaker(s)
- B. Turn **BOTH** PV disconnect switches to the "ON" position
- C. Press the ON/OFF Button on the left side, and the blue light should turn on

Indicator LED's

DC

- A. Green = DC Solar Panels are producing
- B. Off = Solar Panels are not producing

AC

- A. Green = Grid (or Gen or AC Coupled) is Connected
- B. Off = grid is not Connected

Normal

- A. Green = Sol-Ark is working properly
- B. Off = Sol-Ark is not working properly

Alarm

- A. Red = Alarm. Check the alarms menu
- B. Off = No alarms

Verify Grid, Battery, PV voltage BEFORE turning on the unit (**WHILE THE UNIT IS OFF**)



Turn ON with one of three sources of power:
1) PV 2) Grid 3) ON/OFF Battery

Power Cycle Sequence

1. Make sure that Sol-Ark 30K-3P-208V is properly connected to the batteries, panels, grid, etc. (see system wiring diagram)
2. Turn on the external battery disconnect
3. Turn on grid power from the disconnect
4. Make sure Solar panel inputs are not connected to Ground, then Turn on DC disconnect switches (x2)
5. Press the power button on the left SIDE of the unit
6. Turn on external load disconnect
7. Reverse the steps to turn off



DO NOT turn off Battery Disconnect if any current is flowing in or out of the battery.

Maximum combined **OUTPUT**
(AC Coupled+DC_{inverted})
180A x 120V x3
SW Limit of 65,000W

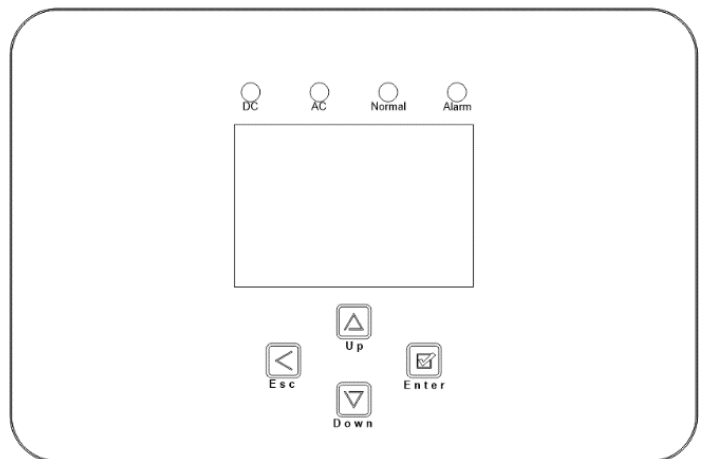

Remote Monitoring Setup

Ethernet Dongle

- Open the dongle (Black device) enclosure and thread the ethernet cable through the hole, and plug it into the RJ45 port
- Reassemble the dongle housing, plug into the Sol-Ark, and secure it with screws (x2 M4x12)
If all is well, you will see solid red and green lights
- Register the dongle via the app or www.mysol-ark.com

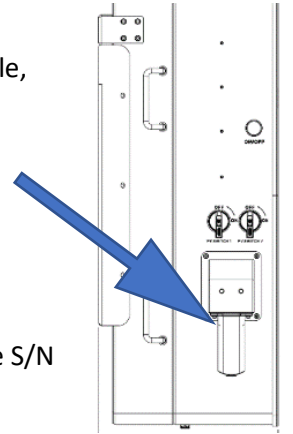

Wi-Fi (Via Cell Phone or computer)

- Plug the Wi-Fi dongle into the Wi-Fi port on the LEFT side of the Sol-Ark
- Using your device, look for an "EAP" network containing the last five digits of the dongle S/N
- Password: 12345678
- Follow the instructions on the upcoming pages



You can access PowerView on a computer with the following link:

<http://www.mysol-ark.com>



Download PV Pro App



iPhone: (Will only show up as PV Pro)
<https://apps.apple.com/lk/app/powerview-pro/id1247121391>

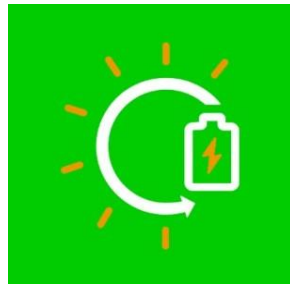

Android
https://play.google.com/store/apps/details?id=com.elinter.app.powerview&hl=en_US&gl=US



Attention Installers

If you plan to add an install to your installer account for monitoring multiple installs, you must first make the plant under the **customer's** account.

Once created, the customer can share the plant, with **Manager permissions**, to the installer via the app ("..." under My Plants) or webpage (press the "..." next to the plant name in Power View).

PV Pro App
Tutorial Video



PV Pro Website
Tutorial Video



Create an Account and Sign In

Account login

Please input your E-mail

Password

SIGN IN

Sign Up | Forgot Password

Sign Up

Phone Number

Please input E-mail

Please input verification code GET CODE

Password

Click [CONFIRM], you agree and are willing to comply (Terms of Service)

SIGN UP

After filling the form click "Create Account"

Account login

Please input your E-mail

Password

SIGN IN

Sign Up | Forgot Password

Add a Plant

Plant Name

Create Plant

0 Online 0 Warning 0 Fault 0 Total

Create time Efficiency

No Data

Plants Equipment Event Me

Scan the QR code on the dongle while plugged in

ETH + Wi-Fi Stick
Firmware: 1.0.0.0
SN: 1440 700 3200
Key: 0000 0000 0000 0000

Please put QR Code in the box

Manual input On

Create Plant

SN E#####

Key #####

Plant Information

Plant Name* TEST

Plant photos

Installed Capacity* 10 kWp

Operating Date* 2021-03-25

Installer Sol-Ark

Address* 5833 Curtis Rd Parker

Time zone* (UTC-6:00)Central Time (US & Cana...)

Plant Type* Energy Storage (DC coupling)

Income information

Currency* \$

On Plant Type, ALWAYS select Energy Storage (DC coupling).

Make sure to pick a unique plant name. (I.E. "Last Name, First four of Address")

Connect the System to the Internet

If Wi-Fi paired with 10.10.10.1, select Done

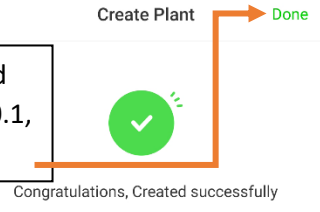

Congratulations, Created successfully

DISTRIBUTION NETWORK

You can click the confirm button in the upper right corner to complete the creation or to configure the network for the collector

Select Distribution Network to pair Dongle with WIFI

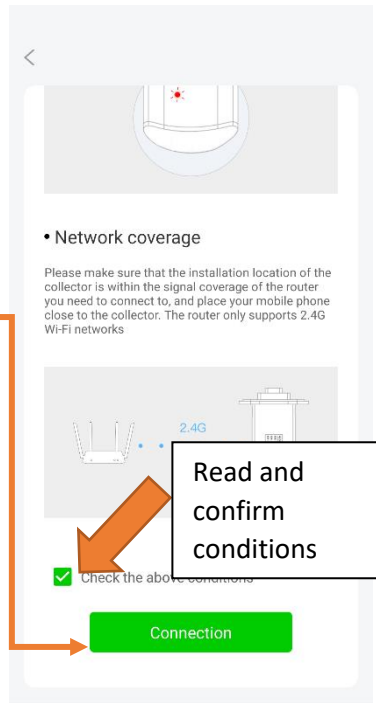

Read and confirm conditions

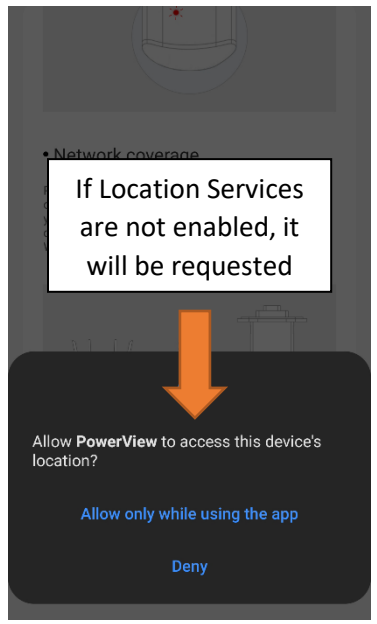

If Location Services are not enabled, it will be requested

Allow PowerView to access this device's location?
Allow only while using the app
Deny

Once you see this screen, go to your **DEVICE'S** Wi-Fi settings and connect to the Wi-Fi network that starts with:
EAP-#####
Password: "12345678"
Return to app once connected

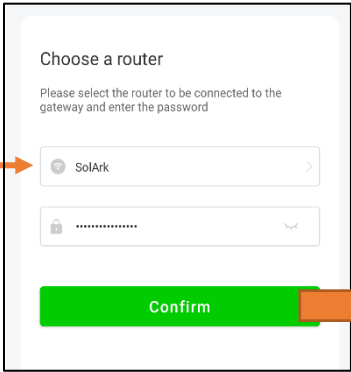

Select the local Wi-Fi network that will be providing the internet connection to the system
Do NOT select the dongle's Wi-Fi network

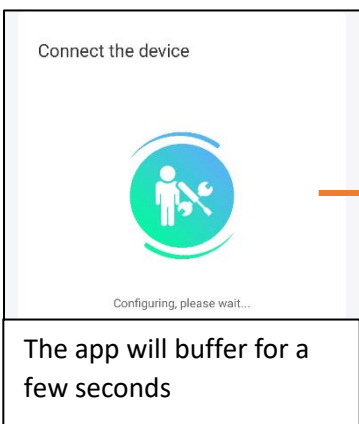

The app will buffer for a few seconds



It takes about 60sec for the lights to turn on after setup
Red LED: Connected to Sol-Ark and has power
Green LED: Connected to Internet and Server
Flashing Green LED: Connected to router but not server (usually a VPN or firewall issue)

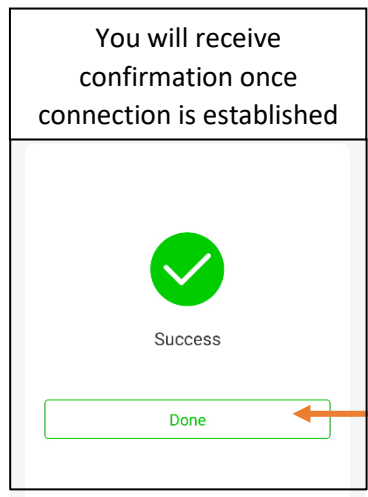

You will receive confirmation once connection is established

Start Monitoring The Data

Select your plant

This screen is the real time view

Graphed data

System info and programming

Alarms



Attention

If you are installing **parallel** systems, **DO NOT** create a plant for each inverter.

Create one plant for the **Master** unit and then use the browser version of PowerView (mysol-ark.com).

Click on the “...” for the **MASTER’s** plant and hit “Add Gateway” then put the S/N and Key of the **SLAVE’s** dongle.

IP Address Setup Instructions (PC or SmartPhone)



Please note that this method only achieves internet connectivity. For registration and account management, please use the app and/or www.mysol-ark.com

Connect to the Dongle Network

- A. Settings → Wi-Fi → Select the Network with EAP- ##### (The last five digits of your SN number)

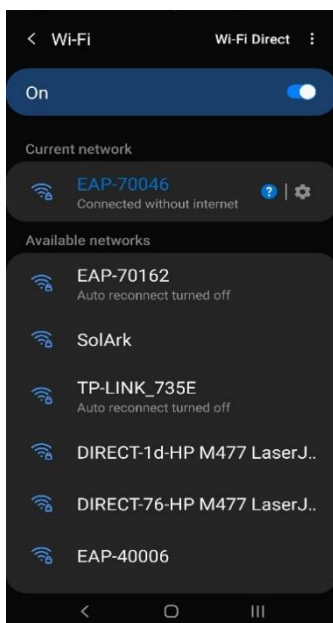

Password: 12345678

***Disclaimer*:** The Wi-Fi dongle does not have internet; You still need to be connected to the dongle for this process.

Login to Web Portal using ANY Search Browser

- Open Google or Safari → type in the search bar: **10.10.10.1**
- Scroll Down to "Wi-Fi Connection"
- Press "Scan" to search local networks

Select Your HOME Network

- Find the home network
- Enter personal Wi-Fi Password
- DO NOT SELECT DONGLE NETWORK**
- Select "Connect"

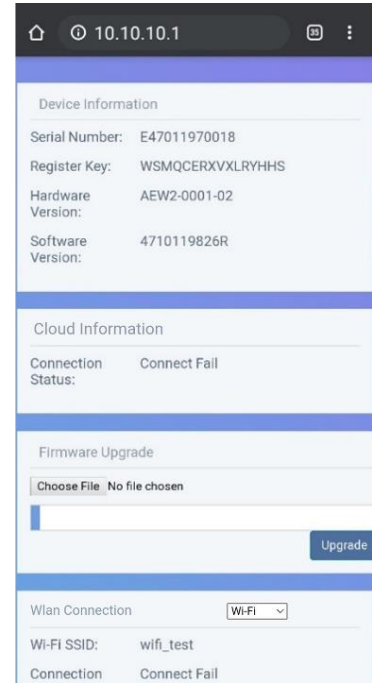
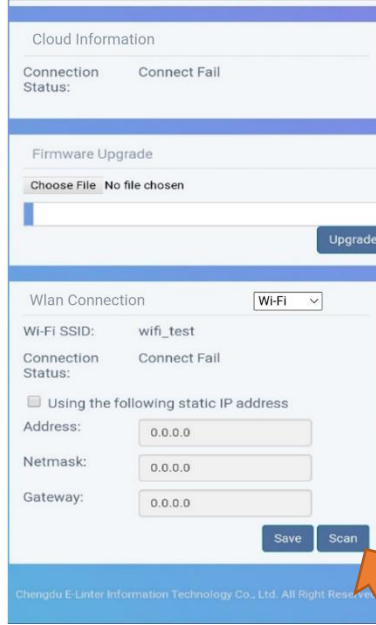

Disclaimer

Connecting the dongle via the IP address only connects the dongle to the internet

YOU MUST STILL CREATE AN ACCOUNT VIA THE POWER VIEW APP

Save Your Information

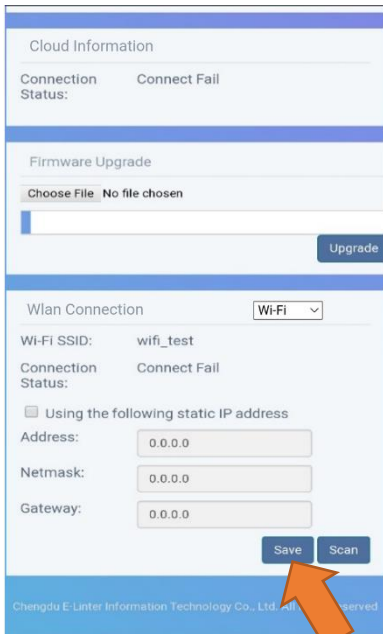

If successful, you should see a Red and Green Light on the Dongle showing a successful connection. Red light may blink at a ~ 1s rate

Red LED: Connected to Sol-Ark and has power.

Green LED: Connected to Internet and Server

Flashing Green LED: Connected to router but not server (usually a VPN or firewall issue)



Main Menus

Solar Today=53KWH Total=559.8KWH

Solar	Grid	INV	USP LD	Batt
0W	0W	0W	0W	0W
0V/0.5A	0.0Hz	60.0Hz	L1: 0V	0.0V/ 0%
M1: 0W	L1: 0V	L1: 0V	L2: 0V	0.00A
364V/0.0A	L2: 0V	L2: 0V	L3: 0V	0.0C
M2: 0W	L3: 0V	L3: 0V	L1: 0W	0.00V/ 0%
0V/0.1A	HM1: 0W	L1: 0A	L2: 0W	0.00A
M3: 0W	HM2: 0W	L2: 0A	L3: 0W	0.0C
362V/0.8A	HM3: 0W	L3: 0A	Gen 60.0Hz 0W	
M4: 0W	LD1: 0W	L1: 0W	L1: 0W	L1: 0W
	LD2: 0W	L2: 0W	L2: 0W	L2: 0W
	LD3: 0W	L3: 0W	L3: 0V	L3: 0W

TEMP

AC:19.4C

System Setup

Basic Setup

Battery Setup

Limiter / Grid Setup

System Alarms

Li-Batt Info

10/14/2022 03:05:27 PM Fri.

Sol-Ark 30K-3P-HV

- ID: #####

- COMM: ####

- MCU: Ver###

System Alarms 1/25/2021 03:05:27 PM Mon.

Alarms Code	Occurred
F13 Grid_Mode_changed	2021-01-13 11:22
F13 Grid_Mode_changed	2021-01-13 11:20

Basic Setup

Basic Setup

Display Time Advanced Factory Reset Parallel

Brightness

Beep

Auto Dim 600S

CANCEL OK

Basic Setup

Display Time Advanced Factory Reset Parallel

Year 2021 Month 10 Day 26

Hour 03 Minute 04 Second 15

Seasons Start M-D: 1 - 1, 4 - 1, 8 - 1

End M-D: 4 - 1, 8 - 1, 12 - 1

CANCEL OK

Basic Setup

Display Time Advanced Factory Reset Parallel

Solar Arc Fault ON Clear Arc_Fault

Gen Limit Power 30000W

Load Limit Power 30000W

Grid peak-shaving Power 30000W

Auto detect Home Limit Sensors CT ratio 2000

UPS Time 0ms

CANCEL OK

Basic Setup

Display Time Advanced Factory Reset Parallel

Factory Reset System selfcheck

Lock out all changes Test Mode

Lock Grid Charging & Limited

CANCEL OK

Basic Setup

Display Time Advanced Factory Reset Parallel

Parallel Master Slave

Modbus SN 00

Meter > Grid Meter > Load

Meter Select No Meter

CANCEL OK

Battery Setup

Batt Setup

Batt | Charge | Discharge | Smart Load

Batt capacity: 200Ah BMS Lithium Batt 01

Max A charge: 50A Use Batt V charged

Max A discharge: 50A No Battery

Parallel bat1&bat2 Activate Battery1

Activate Battery2

CANCEL OK

Batt Setup

Batt | Charge | Discharge | Smart Load

StartV: 490.0V 490.0V Float V: 552.0V

Start%: 30% 30%

A: 40A 40A

Gen Charge Grid Charge

Gen Force

CANCEL OK

Batt Setup

Batt | Charge | Discharge | Smart Load

Shutdown: 170.0V 10%

Low Batt: 165.0V 20%

Restart: 180.0V 50%

Batt Empty V: 160.0V BMS_Err_Stop

CANCEL OK

Batt Setup

Batt | Charge | Discharge | Smart Load

Use gen input as load output For AC Coupled Input to Gen

On Grid always on High Friz: 65.00Hz

Smart Load OFF Batt: 51.0V 80%

Smart Load ON Batt: 54.0V 90%

CANCEL OK

Limiter / Grid Setup

Grid Param

Limiters | Other

Grid Sell 30000

Limited Power to Home

Limited Power to Load

Time of Use Setup

Time	Power(W)	Batt	Charge	Sell
01:00AM	2000	50%		
05:00AM	2000	50%		
09:00AM	2000	100%		
01:00PM	2000	100%		
05:00PM	2000	50%		
09:00PM	2000	50%		

CANCEL OK

Grid Param

Time of Use Setup

Mon. Tues. Wed. Thur.

Fri. Sat. Sun.

Season1 Season2 Season3

CANCEL OK

Grid Param

Limiters | Other

GEN connect to Grid Input

Zero Export Power: 10W

Batt First Load First

CANCEL OK

Grid Param

Grid Selection | Connect | IP | F(W) | V(W)/V(Q) | P(Q)/P(F)

Grid Mode: 3/3 SRD-UL-1741

Grid Frequency: 50Hz

Grid Reconnect Time: 300s

Power Factor: 1.000

Grid Level: LN:120V/LL:208V(AC)

Phase Type: 0/240/120

IT system-neutral is not GND

CANCEL OK

Grid Param

Grid Selection | Connect | IP | F(W) | V(W)/V(Q) | P(Q)/P(F)

Reconnect

Grid Vol High	142.0V
Grid Vol Low	102.0V
Grid Hz High	61.3Hz
Grid Hz Low	57.7Hz
Reconnect Ramp rate	36s

Normal connect

Grid Vol High	144.0V
Grid Vol Low	100.0V
Grid Hz High	61.5Hz
Grid Hz Low	57.5Hz
Normal Ramp rate	60s

CANCEL OK

Grid Param

Grid selection | Connect | IP | F(W) | V(W)/V(Q) | P(Q)/P(F)

Over Voltage U>(10 min. running mean): 132.0V

HV3	144.0V		HF3	61.50Hz
HV2	144.0V	-- 4.80s	HF2	61.50Hz -- 0.08s
HV1	144.0V	-- 4.80s	HF1	61.50Hz -- 0.08s
LV1	100.0V	-- 2.50s	LF1	57.50Hz -- 0.08s
LV2	100.0V	-- 2.50s	LF2	57.50Hz -- 0.08s
LV3	100.0V		LF3	57.50Hz

CANCEL OK

Grid Param

Grid selection | Connect | IP | F(W) | V(W)/V(Q) | P(Q)/P(F)

Over frequency

Start freq F: 50.20Hz

Start delay: 0.00s

Stop freq F: 51.50Hz

Stop delay: 0.00s

Drrop F: 40%P/Hz

Under frequency

Start freq F>: 49.80Hz

Start delay F>: 0.00s

Stop freq F>: 49.80Hz

Stop delay F>: 0.00s

Drrop F>: 40%PE/Hz

CANCEL OK

Grid Param

Grid selection | Connect | IP | F(W) | V(W)/V(Q) | P(Q)/P(F)

V(W) | V(Q)

V1:109.0%	P1:100%	Lin:20.0%	Lout:5.0%
V2:110.0%	P2:20%	V1:94.0%	Q1:43%
V3:111.0%	P3:20%	V2:97.0%	Q2:0%
V4:112.0%	P4:20%	V3:105.0%	Q3:0%
		V4:108.0%	Q4:43%

CANCEL OK

Grid Param

Grid selection | Connect | IP | F(W) | V(W)/V(Q) | P(Q)/P(F)

P(Q) | P(F)

P1:655%	Q1:0%	Lin:655.3%	Lout:655.3%
P2:655%	Q2:0%	V1:655%	F1:0.000
P3:655%	Q3:0%	V2:655%	F2:0.000
P4:655%	Q4:0%	V3:655%	F3:0.000
		V4:655%	F4:0.000

CANCEL OK

Sol-Ark Menus

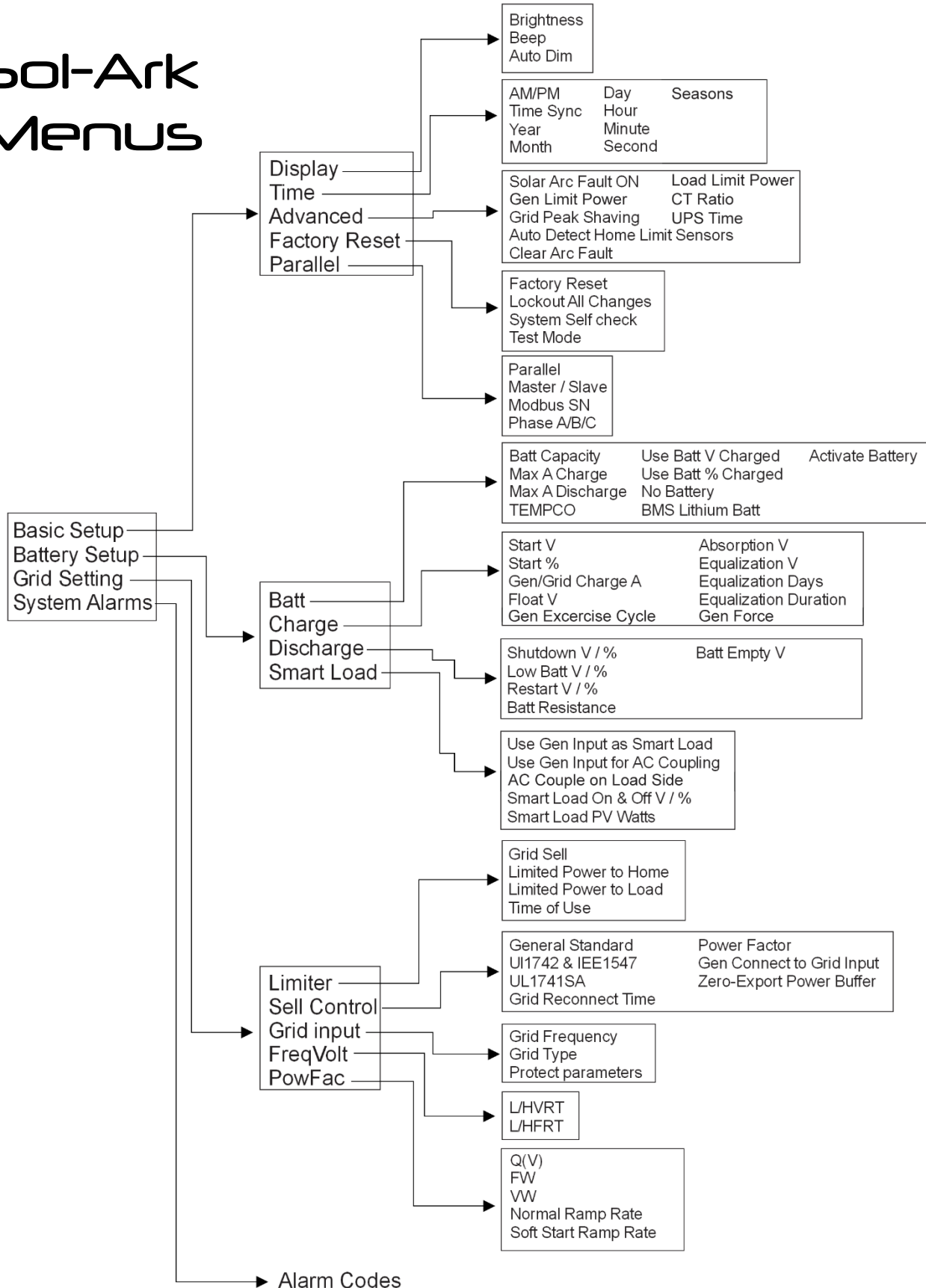

Main Screens (Touchscreen)

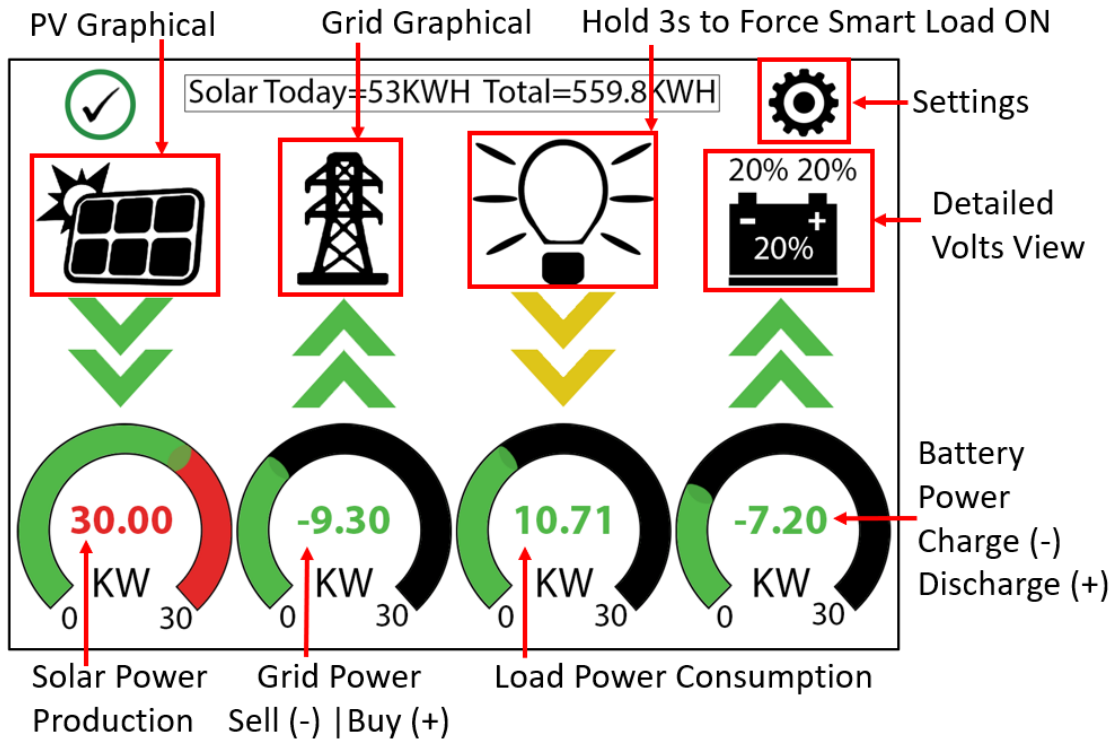

Detailed Volts View (Press Batt Icon)

- Top row = Total power for the column
- Solar Column: Displays voltage and amps per MPPT
 - ⚠ (note: PV Voltage not to exceed 500V)
- Grid Column
 - If selling to the Grid, Grid Watts = negative
 - If buying from the Grid, Grid Watts = **positive**
 - HM = power detected by the external current sensors on the entire home L1 / L2 / L3
 - LD = power detected using internal sensors
- INV Column: Voltage, Amps, and Watts for L1, L2, L3
- UPS LD Column: Load Voltage and Watts for L1, L2, L3
- Batt Column: Voltage/Percentage, Amps, and Temp for Batt 1 and Batt 2
- GEN Column: Generator or AC Coupled Input Volts and watts for L1, L2, L3
- AC Temp = Temperature of AC conversion electronics
 - Batt → AC
 - PV → AC

Solar	Grid	INV	UPS LD	Batt
0W	0W	0W	0W	0W
0V/0.5A	0.0Hz	60.0Hz	L1: 0V	0.0V/ 0%
M1: 0W	L1: 0V	L1: 0V	L2: 0V	0.00A
364V/0.0A	L2: 0V	L2: 0V	L3: 0V	0.0C
M2: 0W	L3: 0V	L3: 0V	L1: 0W	0.00V/ 0%
0V/0.1A	HM1: 0W	L1: 0A	L2: 0W	0.00A
M3: 0W	HM2: 0W	L2: 0A	L3: 0W	0.0C
362V/0.8A	HM3: 0W	L3: 0A	Gen 60.0Hz 0W	
M4: 0W	LD1: 0W	L1: 0W	L1: 0V	L1: 0W
TEMP	LD2: 0W	L2: 0W	L2: 0V	L2: 0W
AC:19.4C	LD3: 0W	L3: 0W	L3: 0V	L3: 0W

PV Solar Graphical View

- Displays power production over time for the PV array
- Use up/down buttons to navigate between days
- Month view, Year view, and Total view

Grid Graphical View

- Displays power drawn from and sold to the grid over time



Note: Reversed Grid Watt values may indicate incorrectly installed current sensors (reversed polarity). See Page 38.

- B. Bars above the line indicate power bought from the grid
- C. Bars below the line indicate power sold back to the grid
- D. Line Frequency: useful when using off-grid when the generator is connected to grid input to verify the generator output frequency

This view can help determine when the peak power is used in the Home and for Time of Use programming

System Setup Menu

- A. ID = LCD serial #. Sol-Ark Technical Support uses the Wi-Fi serial #.
- B. COMM = LCD software version
- C. MCU = Inverter software version

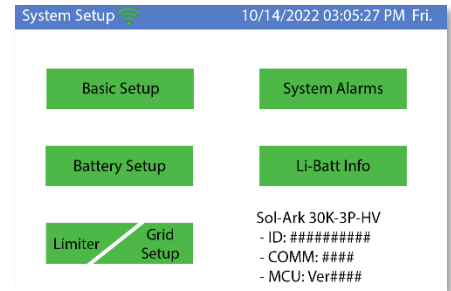

Basic Setup

Display

- A. Brightness adjustment
- B. Auto dim (must be enabled for the warranty to cover the LCD screen)
- C. Enable/disable BEEP

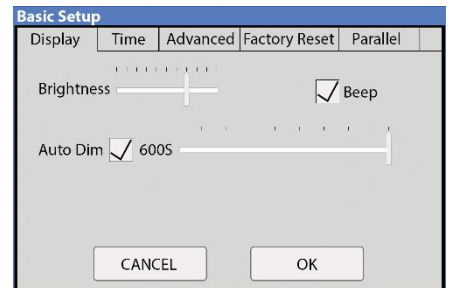

Time

- A. Set the date and time for the system
- B. Set up to three (3) seasons for Time of Use to follow

Load Limit Power

Set the total AC Output of the Sol-Ark; curtails excess power. The default value is always the Maximum output of the Inverter.

Grid Peak Shaving

Set the Sol-Ark's threshold to begin contributing power to keep the power drawn from the grid below the threshold.

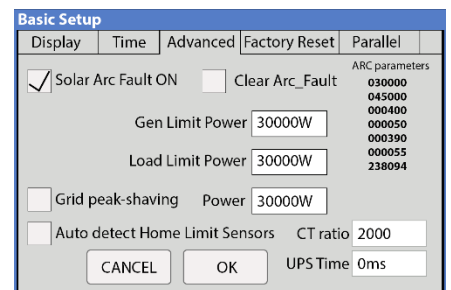

CT Ratio

Set the CT ratio; the Default value is 6000. Please **DO NOT** change this value unless you speak with support; 3rd party CT sensors require our permission not to void the warranty.

UPS Time

Set the UPS transfer time to the chosen value; any value below 5ms will default to a 5ms transfer time.

Parallel (connecting multiple systems)*

Please contact Sol-Ark technical support for parallel operation details.

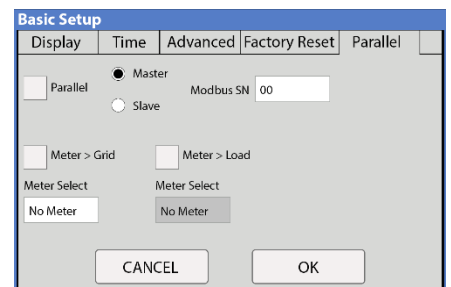

System Alarms

- A. Lists all recorded System alarms in chronological order
- B. sdUse this for Solar Engineering to help with troubleshooting



Battery Setup

Batt



Series = add Voltage | Parallel = add Amp-Hours

Batt Capacity: Enter the battery bank's size connected to the system

Max A Charge: set the max charge rate for the batteries (This also sets the PV → Battery charge rate)

Max A Discharge: set the max discharge for the battery bank (In off-grid mode, the battery bank will discharge 120% of this value for 10 seconds before the Inverter shuts down to prevent battery damage)

Parallel bat1&bat2: Select this to parallel the two battery terminals of the Sol-Ark 30K-3P-208V

BMS Lithium Batt: Closed-Loop Communications and ensure correct Serial Number (01,02, etc.) for the battery

Use Batt V Charged: Displays battery charge and other system values in terms of voltage

Activate Battery 1&2: KEEP ON. This feature will help recover an overly-discharged battery by slowly charging from the solar array or grid

Charge

Float V: Set value according to the manual of the batteries connected to the system

Gen Charge: uses the gen input of the system to charge the battery bank from an attached three-phase generator

Start V: Set the voltage at which the system will AutoStart a connected 3P generator to charge the battery bank

Start percentage: Set the SOC% at which the system will AutoStart a corresponding 3P generator to charge the battery bank

A: Charge rate from the attached Generator in Amps (DC); **size this value according to the generator size**

Grid Charge: use the Grid input to charge batteries from the grid or a sizeable 208V_{AC} three-phase generator only

Gen Force: This is the test function for Gen AutoStart. Enable to trigger two-wire start (pins 1,2 on sensor pinboard 2) and turn on the generator. Disable to disengage the two-wire start and turn off the generator. The generator will not provide power during this test if grid power is available.

The screenshot shows the 'Batt Setup' window with the following settings:

Batt	Charge	Discharge	Smart Load
Batt capacity	200Ah		<input checked="" type="checkbox"/> BMS Lithium Batt 01
Max A charge	50A		<input type="checkbox"/> Use Batt V charged
Max A discharge	50A		<input type="checkbox"/> No Battery
<input type="checkbox"/> Parallel bat1&bat2			<input checked="" type="checkbox"/> Activate Battery1
			<input type="checkbox"/> Activate Battery2

Buttons: CANCEL, OK

The screenshot shows the 'Batt Setup' window with the following settings:

Batt	Charge	Discharge	Smart Load
StartV	490.0V	490.0V	Float V 552.0V
Start%	30%	30%	
A	40A	40A	
<input type="checkbox"/> Gen Charge		<input checked="" type="checkbox"/> Grid Charge	
<input type="checkbox"/> Gen Force			

Buttons: CANCEL, OK

Discharge

Shutdown V: battery voltage at which the Inverter will shut down (battery symbol on the home screen will turn red)

Low Batt: Low battery voltage (battery symbol on the home screen will turn yellow)

Restart: battery voltage at which AC output will resume after a shutdown

Batt Empty V: sets reserve capacity and improves % SOC calculations. It is not Batt_I adjusted

Batt	Charge	Discharge	Smart Load
Shutdown	170.0V	10%	
Low Batt	165.0V	20%	
Restart	180.0V	50%	
Batt Empty V	160.0V		<input type="checkbox"/> BMS_Err_Stop

Smart Load (Gen Terminal)

- This mode utilizes the Gen input connection as an **OUTPUT** that only receives power when the battery exceeds a user-programmable threshold
- Enable "Use gen input as load output" to power high-power loads such as a water heater, irrigation pump, AC unit, pool pump, etc. We call these luxury loads

Batt	Charge	Discharge	Smart Load
<input type="checkbox"/> Use gen input as load output			<input type="checkbox"/> For AC Coupled Input to Gen
<input type="checkbox"/> On Grid always on			High Frz 65.00Hz
Smart Load OFF Batt	51.0V	80%	
Smart Load ON Batt	54.0V	90%	

Smart Load OFF Batt

Battery voltage at which the Gen Load will stop receiving power

Smart Load ON Batt

Battery voltage at which the Gen Load will start receiving power



Using Gen load for a water heater, we recommend that only one leg (120V) be connected to the bottom element. This significantly reduces the power consumption of the water heater while retaining core functionality (it will heat water, only slower).



Per NEC, the Gen Load is limited to 57.6kW [160A @120V x 3] (Do not exceed!)

Solar Watts is for on Grid

- The system waits to turn on the smart load until enough PV power is produced (when on the grid)

AC Coupling Settings ("For AC Coupled Input to Gen")

- To use the Gen input terminal as an AC coupled input, check the "For AC Coupled Input to Gen" box (this feature will also work with three-phase "Grid-Tied" Inverters)
- In this mode, the meaning of "Smart Load OFF Batt" and "Smart Load ON Batt" change

Smart Load OFF Batt: The SOC % or V at which the AC coupled inverter(s) are shut down when in off-grid mode



90% recommended

Smart Load ON Batt: The SOC % or V at which the AC coupled inverter(s) are turned on when in off-grid mode



60%-80% recommended

When On-Grid, the AC-coupled Inverter is always on, selling any extra power back to the grid.

Ensure you can (are allowed) sell power to your utility provider when using AC Coupled PV Arrays on-grid

To use the LOAD terminal for AC coupling grid-tied Inverter (s)

- A. You must select "AC couple on load side"
- B. The Gen terminals are not used (even though the GEN terminals are not physically being used for this mode, AC coupling on the LOAD side prevents the use of the GEN terminals)
- C. Wire as shown in the preceding example diagram labeled "Load side AC coupling example"



Some load-side AC coupling installations require a line-side tap instead of landing on a service panel.

Limiter Tab / Grid Setup

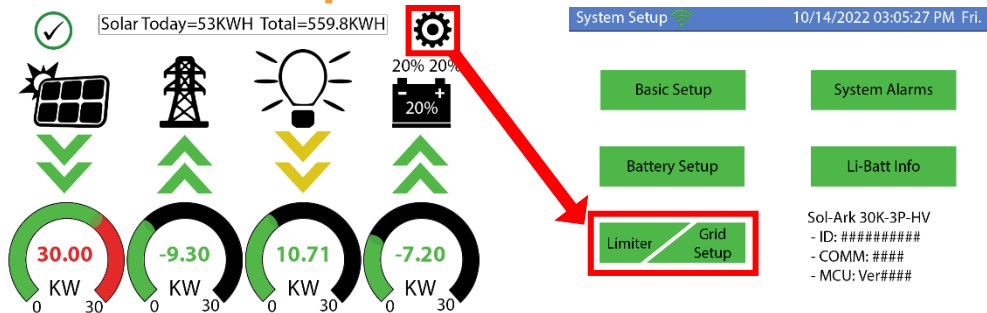

Limiter Tab / Other Tab

Grid Sell: maximum watts sold to the grid

Limited Power To Home: Limits power produced by the system to match the demand of the Home (CTs Required, see pg. 41)

Limited Power To Load: Limits power produced by the system to match the demand of connected loads

Time Of Use: Use the batteries while the grid is ON

Time: When the System will sell batt/PV power to the Grid or Home

Power(W): Max watts called from the battery only at each time slot

Batt: The battery voltage or % at which the system will limit selling to the Grid or Home from the battery. The system will drain the battery until reaching that percent/voltage.

Charge: Enables grid/gen charging up to the voltage or percentage specified on the line during a selected period. PV will always charge 100%. If using a generator, select the charge box for the times that may need the generator, and the Gen will charge the battery to the voltage of the percentage specified in the "Batt" column.

Sell: The sell check box allows us to discharge the battery for grid sell-back for that time slot.

GEN connect to Grid Input: Enable if Generator connects to the AC Grid terminals

Zero Export Power: Power that is always drawn from the grid

Batt First vs. Load First: Internal Use, Select "Batt First"

Grid Param		Time	Power(W)	Batt	Charge	Sell
<input type="checkbox"/>	Grid Sell 30000	01:00AM	2000	50%	<input type="checkbox"/>	<input type="checkbox"/>
<input type="checkbox"/>	Limited Power to Home	05:00AM	2000	50%	<input type="checkbox"/>	<input type="checkbox"/>
<input checked="" type="checkbox"/>	Limited Power to Load	09:00AM	2000	100%	<input type="checkbox"/>	<input type="checkbox"/>
<input checked="" type="checkbox"/>		01:00PM	2000	100%	<input type="checkbox"/>	<input type="checkbox"/>
<input type="checkbox"/>	Time of Use Setup	05:00PM	2000	50%	<input type="checkbox"/>	<input type="checkbox"/>
<input type="checkbox"/>		09:00PM	2000	50%	<input type="checkbox"/>	<input type="checkbox"/>

Grid Param

Limiters Other

GEN connect to Grid Input

Zero Export Power 10W

Batt First Load First

CANCEL OK



Note: If you need the batteries to never charge from the grid, **uncheck** the "Grid Charge" box under the charge tab of the battery menu. See Charge Tab under Batt Setup

Selecting Power Mode (Limiter Tab Details)

Sol-Ark 30K-3P will simultaneously use various power sources available to meet the load demand. The following power modes allow the user to determine the power sources available to the Sol-Ark 30K-3P-208V.

Limited Power to Load / Self Consumption

- A. Sol-Ark will only power loads connected to the load output
- B. It will not produce more power than what the connected loads require
- C. This mode will **NOT** sell back to the Home nor Grid (Grid Terminal)

Limited Power to Home (Zero-Metering)

Main Menu → System Settings → Grid Setup → Limiter → Limited Power to Home

- A. Pushes power to the whole Home **WITHOUT** selling back any excess to the grid (no net metering agreement required)
- B. This mode requires the use of limiter sensors (see pg. 41)
- C. Power source priority is the same as Grid Sell Back

Grid Sell

Main Menu → System Settings → Grid Setup → Limiter → Grid Sell

- A. This mode allows Sol-Ark 30K-3P-208V to **SELL BACK** any excess power the solar panels produce to the grid.

Power source priority:

1. Solar Panels | 2. Grid | 3. Generator (Manual) | 4. Batteries (until reaching programmable % discharge)

Time Of Use (using batteries during peak power times)

Main Menu → System Settings → Grid Setup → Limiter → Time of Use

- A. Use the batteries to reduce power consumption from the grid during a user-programmable peak pricing time

Power source priority:

1. Solar Panels | 2. Batteries (programmable % discharge) | 3. Grid (control when Grid charges) | 4. Generator

Grid Param		Time	Power(W)	Batt	Charge	Sell
<input type="checkbox"/>	Grid Sell 30000	01:00AM	2000	50%	<input type="checkbox"/>	<input type="checkbox"/>
<input type="checkbox"/>	Limited Power to Home	05:00AM	2000	50%	<input type="checkbox"/>	<input type="checkbox"/>
<input checked="" type="checkbox"/>	Limited Power to Load	09:00AM	2000	100%	<input type="checkbox"/>	<input type="checkbox"/>
		01:00PM	2000	100%	<input type="checkbox"/>	<input type="checkbox"/>
<input type="checkbox"/>	Time of Use Setup	05:00PM	2000	50%	<input type="checkbox"/>	<input type="checkbox"/>
		09:00PM	2000	50%	<input type="checkbox"/>	<input type="checkbox"/>

Simultaneously select Grid Sell and Limited Power to Home

Load (light bulb) icon on the home screen now includes both the load output power and the home's consumption.

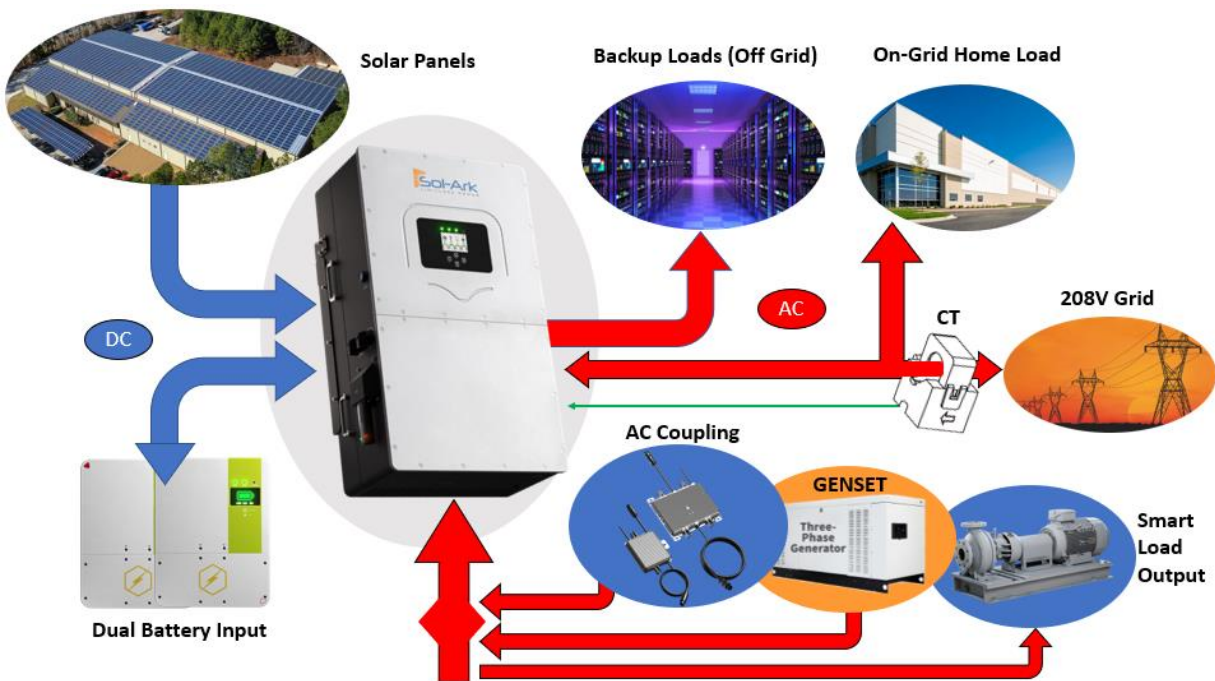

Grid Selection Tab

General Standard: uses Protect Parameters in table

UL 1741 & IEEE1547: Enables sell compliant functionality

UL1741SA: Enables wider Freq, Voltage, and Power Factor

Grid Frequency: Select the Grid Frequency connection

Grid Reconnect Time: Time to reconnect to the grid after grid loss

Grid Level: Several voltage levels for the inverter output voltage when in off-grid mode. LN:120VAC LL:208VAC, LN:115VAC LL:200VAC, LN:133VAC LL:220VAC



Each time the input/output voltage changes, the inverter(s) require a power cycle

Connect Tab

Reconnect: The voltage and frequency range the Inverter uses to reconnect to the grid after a grid loss

Reconnect Ramp Rate: The reconnection power ramp

Normal Connect: The voltage and frequency range the Inverter uses when connecting to the grid for the FIRST time

Normal Ramp Rate: The startup power ramp



We recommend widening the frequency range when connecting a generator to the grid terminal (55-65Hz)

IP Tab

HV1/HV2/HV3: Overvoltage protection point
• 4.8s trip time

LV1/LV2/LV3: Undervoltage protection point
• 2.5s trip time

HF1/HF2/HF3: Over frequency protection point
• 4.8s trip time

LF1/LF2/LF3: Under frequency protection point
• 2.5s trip time

F(W) Tab

The Sol-Ark 30K-3P-208V can adjust the inverter output power according to the grid frequency.

Droop F: The percentage of nominal power per Hertz (Hz)

Example:

Start freq F > 50.2Hz | **Stop freq F** < 51.5Hz

Droop F =40%P/HZ

If the grid frequency reaches 50.2Hz, the Inverter will decrease its active power at Droop F of 40%. The Inverter will stop decreasing output power when the grid frequency is less than 51.5Hz.

Please follow the local grid code.

V(W) / V(Q) Tab

These functions are used to adjust the Inverter's output power (both active power and reactive power) when there are changes in grid voltage

V(W): Will be used to adjust the Inverter's active power according to the set grid voltage

V(Q): Will be used to adjust the Inverter's reactive power according to the set grid voltage

Example:

V2 = 110.0% | P2 = 20% When the grid voltage reaches 110% of the rated grid voltage, the Inverter will reduce its output power (active output power) to 20% rated power

Example:

V1 = 93% | Q1 = 43% When the grid voltage reaches 93% of the rated grid voltage, the Inverter will output 43% reactive output power

P(Q) / P(F) Tab

P(Q): Will be used to adjust the Inverter's reactive power according to the set active power

P(F): Will be used to adjust the Inverter's PF (power factor) according to the set active power

Please follow the local grid code.

CT Sensors enable Limited Power to Home mode (meter zero) and Peak Shaving mode. CT sensors also allow the system to calculate loads powered upstream of the Grid Input in the “home.” We **recommend** CT installation if using multiple inverters or a critical loads panel.

CT Sensor Install Location

- Install the CT sensors on L1 and L2, and L3 upstream of everything in the home except for a Generator Transfer Switch, Knife Blade Disconnect, or Bypass Transfer Switch (upstream of Main Service Panel and Line-Side Tap) – see Diagrams Section Pgs. 8-17

CT Sensor Size

- Each Inverter includes three (3) x 1 3/8” CT sensors (fits up to 4/0 AWG service wires and busbars)
- We have 2” (> 4/0 AWG or Metal Busbars) sensors available for purchase if needed.
- Dimensions refer only to CT sensor hole size; contact Sales at (972) 575-8875 Ext 1 to purchase larger sensors

CT Sensor Wiring

- Wire CT sensor on L1 to pins 1 (white +) and 2 (black -)
- Wire CT sensor on L2 to pins 3 (white +) and 4 (black -)
- Wire CT sensor on L3 to pins 5 (white +) and 6 (black -)
- Twist the black and white wires for each sensor along the length of the run
- If needed, you may extend the range using Shielded Cat 6 (use two twisted pair wires per sensor)
- Use two shielded Cat 6 cables for sensor extensions

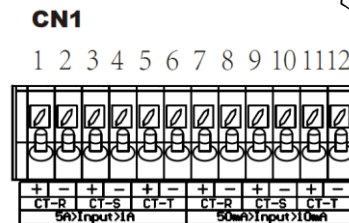

CT Sensor Extension Example

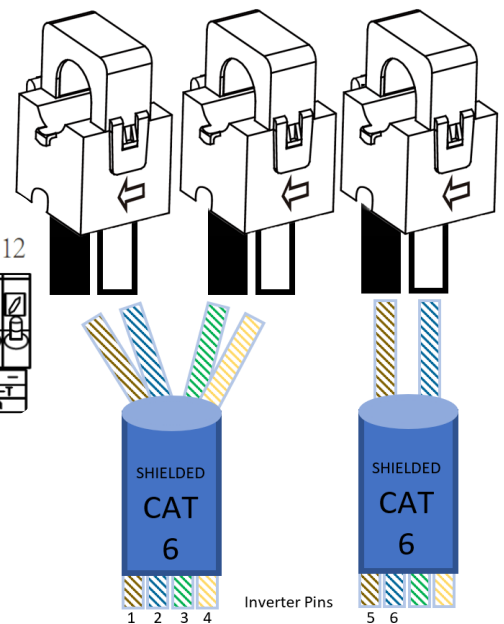

CT Sensor Direction

- The arrow embossed on the CT sensor housing helps determine the direction
- Install CT sensors with the arrow pointing toward the Inverter

Peak Shaving Mode

- Grid Peak Shaving is available with the CT sensors in the location described above and the correct arrow direction

CT Ratio

Set the CT ratio; the default value is 2000/1. **DO NOT** change this value unless you speak with technical support; 3rd Party CT sensors require our permission not to void the warranty.

Parallel 120V_{AC}/208V_{AC} Three-Phase Note*

Please contact Sol-Ark technical support for parallel operation details.

Limiter Sensor Automatic Setup

Requires Batteries and AC coupled panels must be off while detecting.

If you do not have batteries: verify CT sensor placement manually.

- A. Install limiter sensors as previously described (shown in all diagrams). We require a battery and grid connection before starting auto-setup.
- B. Navigate to the "Advanced" Tab of the Basic Setup screen (follow the directions below to get there)
 - A. Touch the gear icon → Touch the Basic Setup button → Select the Advanced tab
- C. Select "Auto detect Home Limit Sensors" and press "OK"
- D. Wait for the Sol-Ark to finish its learning process (Sol-Ark will alternate sell-back magnitude between legs, automatically determining the correct settings for the sensors)
- E. Verify sensors were correctly configured (see Fig. D). If they are not correct, repeat the learn function

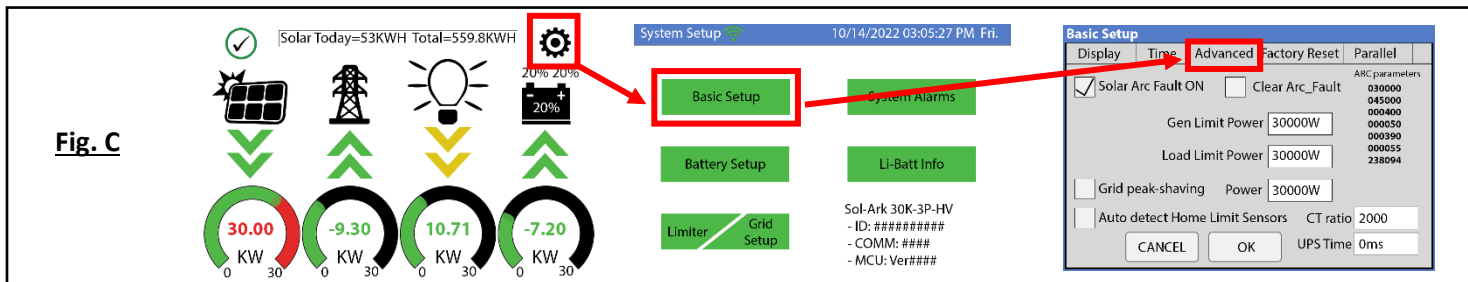

Fig. C

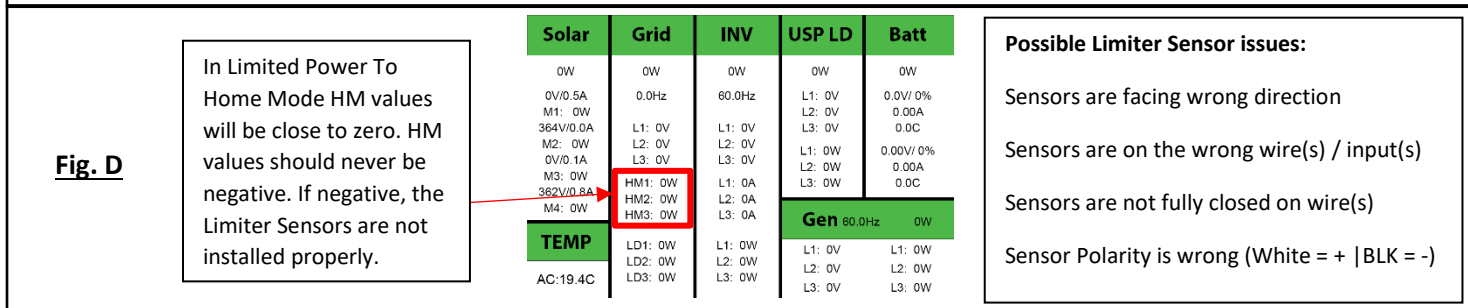

Fig. D



Verifying proper sensor direction:

- Any loads in the home will show a positive HM (+) value in Watts
- Turning on solar panels and enabling Grid Sell should show a negative HM (-) in Watts if you are producing more power than the loads are consuming
- If you turn on Limited Power to Home mode, then HM: ~0 Watts to zero the meter (system matches the loads to within 99%)



If you installed limiter sensors (CTs) for Limited Power to Home selling mode, verifying the proper sensor placement and direction is critical. Remove one sensor from the main L1 connection, and the power should drop to 0W

Off-Grid Install Tips

Sol-Ark 30K-3P-208V will automatically operate in Off-Grid Mode without the grid (under the same power priority as TOU)

- Limiters Sensors are not required for completely Off-Grid installs unless you use Grid Peak Shaving with a Gen connected to the Grid input terminal
- The Grid input Terminal Block on the Sol-Ark should be used as the Generator input (up to 54kW generators) so that you may maintain Smart Load output capability when off-grid. Therefore, you will use Grid Charge (default) in the Battery Setup/Charge menu to enable the generator's ability to charge the batteries. Enable "GEN connect to Grid Input," as shown on the right
- When off-grid, there is no need for a transfer switch: connect the load output of the Sol-Ark to the whole home/building
- Do not use Grid Sell or Limited Power to Home Modes Off-Grid. Only Limited power to load (default)
- The Auto Generator start functions as a 2-wire switch (closes the circuit when needing charging)
 - Auto Gen-start will be triggered when the battery voltage or percent reaches the level programmed in the Battery Setup menu. Then, the generator will continue to charge the batteries until they are about 95% full (this percentage is not programmable) before turning the generator off
- We recommend changing the "Grid Reconnect Time" under the Grid Selection tab of the grid setup menu to 30 seconds; otherwise, the Sol-Ark will not charge from the generator until it has been on for at least 5 minutes per the default value of 300 seconds
- Under setup for Limiter: Other, select "GEN connect to Grid Input." And General Standard in the Grid Selection tab. Then, ensure to widen the input frequency range to 55-65Hz to work with any frequency generator
- If you want to use a wind turbine with the Sol-Ark 30K-3P-208V, the turbine must have a 400V charge controller with a dump load to prevent overcharging the batteries. Connect the charge controller on the turbine to the battery bank the Sol-Ark uses, and the turbine will help charge the batteries
- Don't forget to set the Battery capacity and reasonable charge/discharge rates

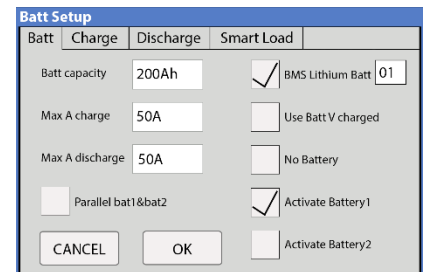
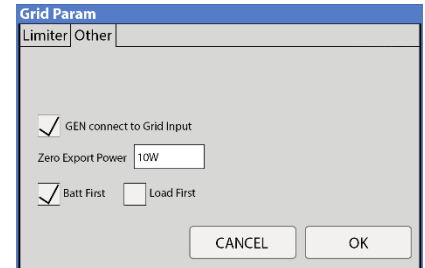
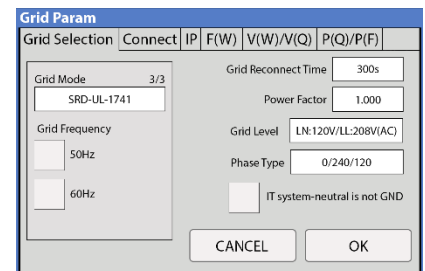
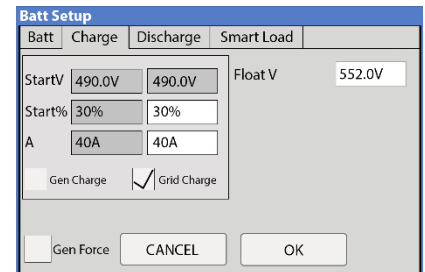
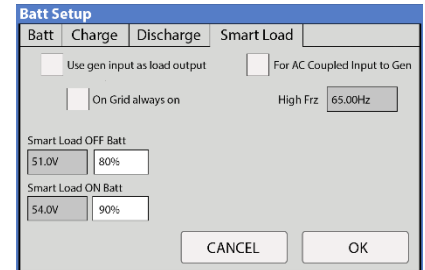

Grid-Tie / No Battery Install Tips

- Under Battery setup, select no Battery & disable Activate Battery (or the system will beep)
- Note: a whole system power cycle is required when changing the battery to no battery settings
- Under the Limiter Setup, select Grid Sell
- Touch the Battery Icon to see the Detailed Volts View to verify your inputs & outputs.

	Time	Power(W)	Batt	Charge	Sell
<input checked="" type="checkbox"/> Grid Sell	30000				
<input type="checkbox"/> Limited Power to Home	01:00AM	2000	50%		
<input type="checkbox"/> Limited Power to Load	05:00AM	2000	50%		
<input type="checkbox"/> Time of Use	09:00AM	2000	100%		
	01:00PM	2000	100%		
	05:00PM	2000	50%		
	09:00PM	2000	50%		

Battery Charging Information

3-Stage Charging

The MPPT has a 3-stage battery charging algorithm for rapid, efficient, and safe battery charging. The figure below shows the stage sequence.

Bulk Charge Stage

In the Bulk Charge stage, the battery is not at a 100% state of charge and has not yet reached the Absorption voltage setpoint. The controller will deliver 100% available solar power to recharge the battery.

Absorption Stage

When the battery has reached the absorption voltage setpoint, we use constant-voltage regulation to maintain battery voltage at the absorption setpoint, preventing heating and excessive battery gassing. The battery can come to a full state of charge at the absorption voltage setpoint. Absorption lasts until batteries charge at 2% of the programmed Ah size.

Float Stage

After the Absorption stage charges the battery fully, the MPPT reduces the battery voltage to the float voltage setpoint. If batts have 100% charge, there can be no more chemical reactions, and all the charging current turns into heat and gassing. The float stage provides a meager rate of maintenance charging while reducing the heating and gassing of a fully charged battery. The purpose of float is to protect the battery from long-term overcharge.

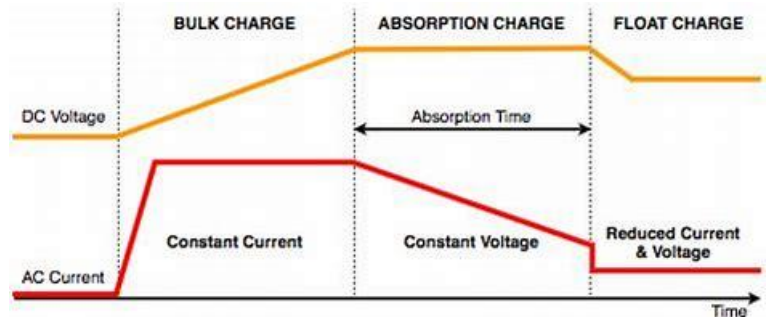

Find our full list of currently supported battery communications
www.sol-ark.com/battery-partners

LCD is not powering on

- Check all connections- at least one of the following power sources is required: PV/Grid/Battery
- Try pressing the power button, touchscreen, or navigation buttons

Panels are connected, but DC Light is not on

- PV voltage must be 170V-500V | It's night

Panels are not producing

- Check for proper wiring on all solar panel connections
- Turn PV disconnect "ON"
- Check that the PV input voltage is not greater than 500V
- If the system says PV = 0V, check the PV polarity

Panels are not producing much power

- PV Wire Strip Length: 5/8". Your batteries are charged; you can test Grid Sell to verify

The system does not keep batteries charged

- Check the charge setting in the Charge Menu

Auto Gen-Start is not working

- Check to make sure your generator is compatible with Auto Start
- Make sure that the Auto Gen Start wire is adequately connected to the Sol-Ark and the generator
- Ensure the generator connected is a three-phase gen and that its phasing is correct

Normal LED isn't on

- Sol-Ark is in pass-through-only mode, with only a Grid connection
- Sol-Ark is not working correctly (Call us)

The alarm light is on

- Check the system alarms menu to identify the alarm

Grid HM value is negative when it should be positive (only applies in limited home mode)

- Limiter Sensors are backward, or L1/L2/L3 sensors are swapped or incorrectly wired. Try Auto Learn

AC Overload Fault or Bus Unbalance Fault

- Check Transfer Switch/Subpanel wiring
- Check for large loads that consume more than the inverter rating

The system connects to the grid and quickly disconnects

- With a digital multimeter, verify your Neutral wire connection (should be 0 Vac referenced to GND)
- Check your Freq is set to 60Hz, and that the 30K-3P measures 120V on L1 / L2 / L3 vs. N
- If overloading: verify 120/208V grid input and load output wires are not swapped
- The L1, L2, and L3 are phase-specific. So, you may have to swap Grid L1 / L2 / L3 for 208V applications

DC Overload Fault

- Check PV voltage
- Make sure you have not wired more than two (2) solar strings in parallel

System is beeping

- Check the system alarms menu to see which alarm has been triggered. Most alarms will self-reset
- There is no battery connected. If not using a battery, select "no battery" and disable "activate batt" in Batt menu
 - Turn off the center button, remove AC Grid and PV Power for the 30s (the screen is dead), and then power up to fully reset the system

Battery cable sparks when connected

- Put the external battery disconnect in the off position before connecting or disconnecting the batteries

The battery symbol on the home screen is red

- The battery is under-Voltage or over-Voltage

The battery symbol on the home screen is yellow

The battery is low, or the charge/discharge current is close to the programmed limit (which is ok)

The grid symbol on the home screen is yellow

- Grid parameters are out of specified range, or the grid is down

System has restarted

- It happens if the system is overloaded, the battery voltage is greater than 500V, or the Software update

Batteries were connected backward

- It can cause **SEVERE** damage! Check the voltage before turning the system on

Why is the LCD screen still on when the power button is off?

- If PV or Grid power, LCD stays on, but the Inverter and loads are off

The Batt % meter is not reaching 100%

- The system needs to go through a small discharge/charge cycle first to calibrate the battery

The generator setup is reading 0Hz

- Select "General Standard" instead of UL1741. Then widen the frequency range to 55Hz-65Hz

Color Touchscreen is Frozen

- Press and hold the escape button [←] for 7-10 seconds

Constant F18 Faults while powering loads within specification

- Click the battery icon on the front of the Inverter and look to see what the AC Output voltage is:

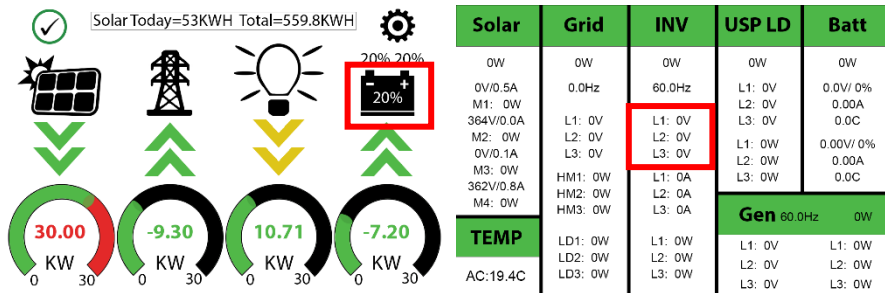

- If the AC Output Voltage is ~120V per leg (this is Wye configuration) and you have more than one Inverter in parallel, contact engineering support for further assistance.

Troubleshooting Phasing Issues

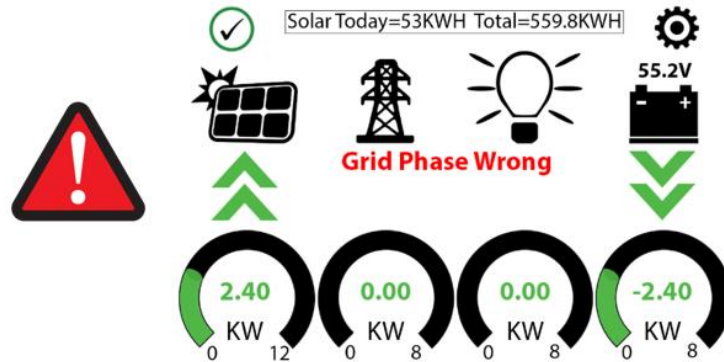

If the Sol-Ark screen shows **Grid Phase Wrong**, there is a phasing issue with your wiring, and it may cause overload faults (F18, F26, F34) and **WILL CAUSE DAMAGE if left unchecked**.

Single Sol-Ark: To locate the improperly wired phases, measure **L1 to L1 (Top Screws)** between the **Grid** and **Load** terminals; you should see 0V AC. Repeat for **L2 to L2** and **L3 to L3** between the **Grid** and **Load** terminals. Attempt to correct the wiring until you only read 0V AC between **L1 to L1 | L2 to L2 | L3 to L3**

Parallel inverters: measure L1 of the **Grid** Terminal to L1 of another unit's **Grid** terminal L1; you should see 0V AC. If in 208V parallel, measure the lines of the same wire color between sol-arks to see if you read 0V AC.

Make sure to correct both the Grid and Load wiring; they both need to be correct.

If the error persists, you will need to check your AC wiring beyond the Inverter and may also need to verify that the phases are properly labeled coming from your meter.

The remainder of the Page is Left Intentionally Blank

Sol-Ark 30K-3P-208V Error Codes

Fault	Instruction	Common Cause/Remedy
F1	DC Inversed Failure	If you have parallel systems and turn one system off, you will get this notification. NOT a fault
F8	GFDI_Relay_Failure	Current Leakage from inverter AC output to Ground, check Ground and neutral are connected at the main panel
F13	Grid_Mode_change	It can happen when not using batteries or if Grid Input settings are changed. This is a notification, NOT a fault. If you switch from No Batt to Battery mode, power the system down completely to restart
F15	AC_OverCurr_Failure	It is usually caused by Loads too large for the Inverter. If off-grid, the battery discharge amps are programmed too low. Overloads can result in F15, F18, F20, or F26
F16	GFCI_Failure	Ground fault. Check PV+ or PV- wiring (which must be ungrounded). Exposed PV conductors + rain can also cause. Check that the neutral line and Ground are not double-bonded (common with portable generators)
F18	Tz_Ac_OverCurr_Fault	Overloaded the Load Output (reduce loads) or overloaded a generator (reduce Gen Start A see pg. 33). Wiring Short on the AC Side can also cause this error. Overloads can result in F15, F18, F20, or F26
F20	Tz_Dc_OverCurr_Fault	It is typically caused by DC current from the battery that is too large (ex: 4 Ton AC Unit) or too much PV current (3 or more strings in parallel). Overloads can result in F15, F18, F20, or F26
F22	Tz_EmergStop_Fault	Initiated Emergency Stop; see sensor pinout table
F23	Tz_GFCI_OC_Fault	PV Ground fault. Check PV+ or PV- wiring (which must be ungrounded, or damage can occur). Typically caused by pinched PV wire grounding the PV+ or PV-. Grounded PV wire can cause F20, F23, or F26
F24	DC_Insulation_Fault	An exposed PV conductor combined with moisture is faulting (can cause F16, F24, F26)
F25	AC_Active_Batt_Fault	No battery connection to the Inverter and Activate Battery is enabled. Disable Activate Battery in settings while no battery is connected
F26	BusUnbalance_Fault	Too much load on one leg (L1 or L2) Vs. the other leg or DC loads on the AC output when off-grid. Grounded PV +/- wire can cause F20, F23, or F26
F29	Parallel_CANBus_Fault	Usually, a communication error for parallel systems, check cables, and MODBUS addresses
F30	AC_MainContactor_Fault	Contact Sol-Ark.com
F31	Soft_Start_Failed	The soft start of a large motor failed
F34	AC Overload Fault	AC Overload or load shorted. Reduce heavy loads
F35	AC_NoUtility_Fault	Grid connection lost
F37	DCLLC_Soft_Over_Cur	Software DC overcurrent
F39	DCLLC_Over_Current	Hardware DC overcurrent
F40	Batt_Over_Current	Batteries exceeded their current discharge limit
F41	Parallel_System_Stop	If one system faults in parallel, this normal fault will register on the other units as they disconnect from grid
F45	AC_UV_OverVolt_Fault	Grid under-voltage causes a disconnect. This will self-reset when the grid stabilizes.
F46	Parallel_Aux_Fault	Cannot communicate with other parallel systems. Check Master = 1, and Slaves are 2-9, ethernet cables are connected
F47	AC_OverFreq_Fault	Grid over Frequency (common in power outages) causes a disconnect. Will self-reset when grid stabilizes
F48	AC_UnderFreq_Fault	Grid under Frequency (common in power outages) causes a disconnect. Will self-reset when grid stabilizes.
F55	DC_VoltHigh_Fault	PV may be higher than 500V. Battery voltage should not be above 500V (depending on the model).
F56	DC_VoltLow_Fault	Batteries are overly discharged, the Inverter is off-grid and exceeds programmed batt discharge current by 20%, or Lithium BMS has shut down. If battery settings are incorrect, this can also happen.
F58	BMS communication fault	Sol-Ark is programmed to BMS Lithium Battery Mode but cannot communicate with a BMS
F60	Gen_Volt_or_Fre_Fault	Generator Voltage or Frequency went outside the allowable range
F61	Button_Manual_OFF	The parallel Slave system turned off without turning off the Master
F63	ARC_Fault	It can be a poor PV connector/connection. And sometimes a false alarm due to powerful lightning storms.
F64	Heatsink_HighTemp_Fault	Check that the built-in fans are running; the ambient temp may be too high. Ensure proper clearance (pg. 2)

For the installer to complete AFTER the system is operational. The purpose is to protect the installer, homeowner, and Inverter.

1. Was a diagram of your installation submitted to Sol-Ark for review? Y/N
 - A. If not, Sol-Ark is not liable for any issues with system performance as a result of the installation, nor is Sol-Ark liable for any changes to installation that are needed to ensure proper system operation.
2. Is the 30K-3P installed where the **LCD is protected from direct sunlight** and has 2" clearance left and right for cooling? Y/N
3. Are all the battery lugs tightened? Y/N
4. 30K-3P should connect to the grid, 30K-3P load ON, Grid disconnect ON, batteries connected, PV input ON and ON button ON. With the Inverter running the Backup load's panel and Grid-connected:
 - A. Did any breakers trip? Y/N
 - B. Did the inverter overload? Y/N
5. If you have problems, please take pictures of these and email them to: support@sol-ark.com
 - A. **Battery icon screen, showing detailed voltages (the screen shown below)**
 - B. **Sol-Ark 30K-3P-208V with batteries and a picture of the user wiring area**
6. Load and solar test
 - A. Press the battery icon for the detailed voltages screen.
 - B. Turn on many loads for the Backup circuits. Are solar panels producing enough power to match the load (provided enough sun)? Y/N
 - C. Program Full Grid Sell Mode. If there are enough panels and sun or light loads in the entire house, the Grid HM measurements will be negative on L1/L2/L3. Are they negative (solar selling back to the grid)? Y/N
 - D. Program Limited Power to Home mode. The Grid HM sensors will be near zero or slightly positive. Are they both near zero and canceling out the whole home power? Y/N
 - E. You have verified the limit sensors are correctly installed. An auto-learn function corrects any mistakes in CT limiter wiring (provided you have batteries). Program in the correct Grid mode the customer will use.
7. Did you program the correct Ah for the battery bank and max Amps charge/discharge? Y/N
8. Did you program the correct battery charge voltages for your battery type? Y/N
9. **Turn off the AC breaker, so 30K-3P operates in an off-grid mode for several minutes.** Are appliances still powered? Y/N
10. **Turn off the PV inputs, running only on batteries for several minutes.** Are appliances still powered? Y/N
11. Turn on the PV inputs and AC Grid inputs.
12. Did you set up the Wi-Fi plug to the customer's internet? Y/N
13. Absolutely important for software updates. Did you help the customer register system on the Monitoring App? Y/N
14. Does the customer have a standby generator or a small portable Generator? Y/N
 - A. Did you turn off UL1741/IEEE1547 (use General Standard) and reprogram grid freq. range to 55-65Hz? Y/N
 - B. Did you enable Gen charging and adequately set the charge current if using a small gas generator on Gen inputs? Y/N



This checklist must be filled out and submitted to register your warranty. Please visit:

<https://www.sol-ark.com/register-your-sol-ark/>

Installer Name

Installer Signature

Date

Customer Name

Customer Signature

Date

10-Year Limited Warranty for SOL-ARK (Portable Solar LLC) Products. Sol-Ark provides a Ten-year (10) limited Warranty ("Warranty") against defects in materials and workmanship for its Sol-Ark products ("Product"). The term of this warranty begins on the Product(s) initial purchase date or the date of receipt of the Product(s) by the end user, whichever is later. This must be indicated on the invoice, bill of sale from your installer. This warranty applies to the original Sol-Ark Product purchaser and is transferable only if the Product remains installed in the original use location. Please call Sol-Ark to let us know if you are selling your home and give us the name and contact of the new owner.

The warranty does not apply to any Product or Product part that has been modified or damaged by the following:

- ❖ Installation or Removal (examples: wrong voltage batteries, connecting batteries backward, damage due to water/rain to electronics, preventable damage to solar wires.)
- ❖ Alteration or Disassembly
- ❖ Normal Wear and Tear
- ❖ Accident or Abuse
- ❖ Unauthorized Firmware updates/software updates or alterations to the software code
- ❖ Corrosion
- ❖ Lightning: unless using EMP hardened system, then Portable Solar will repair the product
- ❖ Repair or service provided by an unauthorized repair facility
- ❖ Operation or installation contrary to manufacturer product instructions
- ❖ Fire, Floods, or Acts of Nature
- ❖ Shipping or Transportation
- ❖ Incidental or consequential damage caused by other components of the power system
- ❖ Any product whose serial number has been altered, defaced, or removed
- ❖ Any other event not foreseeable by Portable Solar, LLC

Contact Us: 1-972-575-8875

For Info/Purchasing:
sales@sol-ark.com | ext.1

For Tech Support/Warranty Claim:
support@sol-ark.com | ext.2

For Administrative Help:
ext.3

Sol-Ark (Portable Solar LLC) liability for any defective Product, or any Product part, shall be limited to the repair or replacement of the Product, at Portable Solar LLC's discretion. Sol-Ark does not warrant or guarantee workmanship performed by any person or firm installing its Products. This warranty does not cover the costs of installation, removal, shipping (except as described below), or reinstallation of Products or parts of Products. LCD screens and fans are covered for five years from the date of purchase.

THIS LIMITED WARRANTY IS THE EXCLUSIVE WARRANTY APPLICABLE TO SOL-ARK (PORTABLE SOLAR LLC) PRODUCTS. SOL-ARK EXPRESSLY DISCLAIMS ANY OTHER EXPRESS OR IMPLIED WARRANTIES OF ITS PRODUCTS. SOL-ARK ALSO EXPRESSLY LIMITS ITS LIABILITY IN THE EVENT OF A PRODUCT DEFECT TO REPAIR OR REPLACEMENT IN ACCORDANCE WITH THE TERMS OF THIS LIMITED WARRANTY AND EXCLUDES ALL LIABILITY FOR INCIDENTAL OR CONSEQUENTIAL DAMAGES, INCLUDING WITHOUT LIMITATION ANY LIABILITY FOR PRODUCTS NOT BEING AVAILABLE FOR USE OR LOST REVENUES OR PROFITS, EVEN IF IT IS MADE AWARE OF SUCH POTENTIAL DAMAGES.

Return Policy - No returns will be accepted without prior authorization and must include the Return Material Authorization (RMA) number. Please call and talk to one of our engineers to obtain this number at 972-575-8875.

Return Material Authorization (RMA) A request for an RMA number requires all of the following information: 1. Product model and serial number; 2. Proof-of-purchase in the form of a copy of the original Product purchase invoice or receipt confirming the Product model number and serial number; 3. Description of the problem; 4. Validation of problem by Technical Support, and 5. Shipping address for the repaired or replacement equipment. Upon receiving this information, the Sol-Ark representative can issue an RMA number.

Any returned product must be brand new, in excellent condition, and packaged in the original manufacturer's carton with all corresponding hardware and documentation. Returns must be shipped with prepaid freight and insured via the carrier of your choice to arrive back at Portable Solar within 30 days of your initial delivery or pick-up. **Shipping charges will not be refunded.**

All returns are subject to a 35% restocking fee. **No returns will be accepted beyond 30 days of the original delivery.** The value and cost of replacing missing items (e.g., parts, manuals, etc.) will be deducted from the refund. If you have any questions regarding our return policy, please email us at sales@sol-ark.com or call us at the number above during regular (M-F) business hours.

Sol-Ark 30K-3P-208V Install Operational Verification Checklist Questionnaire must be filled out, signed, and dated to secure full warranty coverage.